

SG520 — FRONT VIEW

JBL

SG520 SERVICE MANUAL REPLACEMENT PARTS

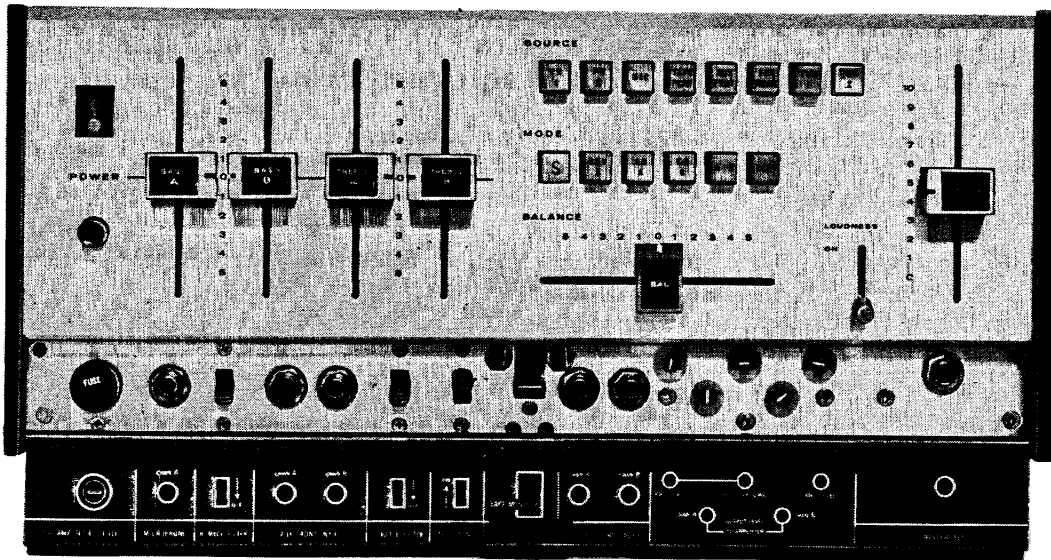

Figure 1-1

Section 1

FUNCTIONS OF CONTROLS AND CONNECTIONS

1.1 PRIMARY FRONT PANEL CONTROLS

- 1.1.1 **POWER.**—The POWER pushbutton is an alternate switch; push it once to turn on the system — push it again to turn the system off. When power is applied, the buttons which happen to be depressed in the MODE or SOURCE bank are illuminated. The main on-off switch controls not only the Graphic Controller but also the back panel switched AC outlets.
- 1.1.2 **TONE CONTROLS.** — The four vertical straight-line controls at the left of the front panel permit the operator to emphasize or diminish bass and treble frequencies independently. Most of the time these are used as ganged controls. By grasping both bass controls at once, for example, they can be moved up and down at the same time so that exactly the same tone control setting is supplied to both channels. On the other hand, to give more-bass boost to one loudspeaker than the other, only the desired control is used.
- When the markers are centered at the '0' position, the response curve of the SG520 is flat.
- 1.1.3 **SOURCE PUSHBUTTONS.**—The top row of eight pushbuttons selects the program source which will be used. Some of these are designed for high-level inputs: devices which provide at least 1/4-volt of signal. Others supply additional amplification for low-level devices such as microphones or phonograph pickups. Individual input sources are described in paragraph 1.4.
- 1.1.4 **MODE PUSHBUTTONS.**—The six pushbuttons in the lower row control the manner in which the stereo channels are fed to the loudspeakers. The TEST button is used in conjunction with the F-22 Remote Relay assembly to permit rapid balance of the entire electrical components. A detailed description of the F-22 operation and TEST switch will be found in Sect. 3.5.
- 1.1.5 **BALANCE CONTROL.**—Sliding the BALANCE control toward the left shifts the emphasis to the left-hand speaker; moving it toward the right shifts the emphasis to the right-hand speaker. When the BALANCE control is at the '0' position (and all of the secondary controls have been properly adjusted) the two channels (A and B) will have identical gain.
- 1.1.6 **VOLUME CONTROL.**—The VOLUME control is also a straight-line attenuator. It controls the level of both channels simultaneously.

1.1.7 **LOUDNESS CONTROL.**—This switch controls the way in which the volume control operates. With loudness switched off, the VOLUME control adjusts only sound intensity. With the loudness switched ON there is emphasis placed on the very low and very high frequencies as the volume is decreased. This compensates for the tendency of the human ear to lose these frequencies at low listening levels. When it is desired to accomplish all compensation with the individual bass and treble controls, then the LOUDNESS control can be switched off.

1.2 CONCEALED SECONDARY FRONT PANEL SWITCHES AND JACKS

The lower portion of the face panel of the Graphic Controller is covered by a bottom-hinged panel which conceals infrequently-used controls, and input and output connectors. This puts them in a readily accessible location but out of sight when not in use.

1.2.1 **FUSE.** — At the far left is a Slo-Blo fuse. A 3/10 AMP. fuse is required for 110-120 volt operation, 15/100 AMP. for 220-240 volt operation. This acts as protection for the Graphic Controller's internal circuitry. The AC outlets located on the back of the Graphic Controller are not fused.

1.2.2 **MICROPHONE JACK.**—Directly to the right of the fuse is a microphone jack for Channel A. The signal from the microphone jack is fed to the amplifier when the MIC pushbutton is pressed.

1.2.3 **RUMBLE FILTER.**—The purpose of rumble filter is to diminish low-frequency noise which may be generated by some record changers, or some of the noises coming from older records. This slide switch is normally kept in the down or OFF position.

1.2.4 **AUXILIARY FRONT INPUTS.**—These are high-level input jacks, one for Channel A and one for Channel B. They are controlled by the SOURCE button marked AUX FRNT. These jacks allow connection of temporary inputs without having to disrupt the permanent connections made on the back panel.

1.2.5 **SCRATCH FILTER.**—This serves to get rid of objectionable high-frequency noises in poor or old records, a noisy tape recording, or excessive noise in a FM stereo broadcast.

1.2.6 **TEST TONE SWITCH.**—This switch will usually be in the up or ON position when you use the TEST button in the MODE bank. A more detailed description of the use of this feature is given in paragraphs 3.3 and 3.5.

1.2.7 **TAPE MONITOR.**—This switch allows connection of a 3-head tape recorder for recording directly from any program set up on the Graphic Controller, and at the same time allows listening to the actual recording as picked up by the playback head. Most high-quality tape recorders have separate recording and playback preamplifiers and will enable use of this feature. When the hinged panel is closed, the TAPE MONITOR switch automatically goes back to its OFF position.

1.2.8 **OUT TO RECORDER.**—A pair of jacks marked CHANNEL A and CHANNEL B allow making recordings directly from the Graphic Controller. The signal which appears at the OUT TO RECORDER jacks is not affected by the VOLUME or TONE controls. A second set of jacks are located on the rear panel. Generally, the front panel connections will be used only for temporary connections for portable machines.

1.2.9 **HEADPHONES JACK.**—The next item, to the extreme right, is the HEADPHONES jack used for monitoring. When headphones are plugged in, signals to the power amplifier are disconnected and speakers are muted. The signal level at the headphone jack is sufficient to give satisfactory results with most 8-16 ohm phones (although better performance will be realized with 500-600 ohm or high impedance units).

1.3 FRONT PANEL SCREWDRIVER ADJUSTMENTS

1.3.1 **PH LEVEL.**—A separate control is provided to adjust the loudness of each phonograph input. This allows trimming these sources so that when switching from one input to another there will not be a sudden change in the loudness level.

1.3.2 **PH 1 STEREO BALANCE.**—A balance control is also provided for the phono-1 input. This makes it possible to compensate for any minor unbalance in the signals supplied from the two channels of the phono-1 pickup cartridge. Once this auxiliary balance is set, it matches the SG520 to a particular pickup, and it need not be re-adjusted unless the pickup cartridge is changed.

1.3.3 OUTPUT LEVEL TO AMPLIFIER.—Separate output level controls allow adjustment of the strength of the signal which is fed to a JBL Solid State Energizer or other stereo power amplifier. These controls are set to accomplish two functions: first, to adjust the gain of each channel individually so that with the main BALANCE control in its 'O' position, the listener hears properly balanced stereo on particular speakers. Secondly, the output level controls limit the loudness at which you can run the system. To prevent accidental overdriving of the power amplifier or loudspeakers, and to give the proper range of operation for the volume control, the output level controls should be set so that normal program material is reproduced just a little louder than one would ever want to hear it when the VOLUME control is set at '8'.

1.4 BACK PANEL CONNECTIONS

All jacks on the back panel receive standard phono pin-plug connectors. TO PREVENT POSSIBLE DAMAGE TO THE POWER AMPLIFIER (OR ENERGIZER) OR SPEAKERS, PLUG OR UNPLUG CABLES ONLY WHEN SYSTEM IS TURNED OFF.

All connections in top row are Channel A. (Left-hand source of sound when facing loud-speakers.) All connections in bottom row are Channel B. (Right-hand source of sound when facing loud-speakers.) For connecting monophonic sources, use either one plug in Channel A (which requires the use of the A+B button) or use a 'Y' connector.

1.4.1 CHASSIS GROUND.—At the extreme left of the panel is a spring-loaded terminal provided for connecting to any equipment which requires a separate ground wire. It also can be used for connecting the entire system to a cold water pipe as a ground.

1.4.2 PHONO 1.—Input from any low-level pickup which requires standard RIAA equalization (any high-quality cartridge having a minimum of one millivolt rated output).

1.4.3 PHONO 2.—Input from a second low-level pickup cartridge or from a tape head. The tape head connection is required for a tape playback deck which has no electronics built in. To change the equalization from Magnetic Phono pickup to Tape Head, remove the chassis bottom plate and adjust the equalization switch to the desired position. The switch is located on a bracket immediately behind the front panel output level controls. The positions of the slide switch are marked MAG PHONO and TAPE HEAD. Refer to Fig. 4-2.

1.4.4 MICROPHONE.—Inputs from any high-impedance microphone or pair of microphones can be connected to these inputs. Generally speaking, no more than 25' of shielded cable should be used. If making a long run of wire to a microphone in a remote location, this should be a low-impedance microphone and connected through a matching transformer to the Graphic Controller. Separate microphone jacks for Channel A and Channel B are found on the back panel. The Channel A microphone input also appears on the front of the Graphic Controller.

1.4.5 TAPE PLAY.—Inputs to these jacks may be from any tape machine which has its own electronics built in. These jacks are the only input jacks which are not shorted when unused. ALL OTHER INPUTS REMAIN SHORTED UNLESS THE APPROPRIATE SOURCE BUTTON IS DEPRESSED.

1.4.6 AUX REAR.—This is an all-purpose input which can be connected to any program source which puts out 0.3 volts of signal or more.

1.4.7 TUN 1.—The most often used tuner should be connected to this input.

1.4.8 TUN 2.—Used for connection of a second tuner.

1.4.9 OUT TO RECORDER.—Outputs from these jacks connect to the "line" or high-level inputs on a tape recorder. The jacks are duplicated on the front panel for connection to a portable machine. Note that the Graphic Controller TONE BALANCE and VOLUME controls have no effect on the signals which appear at these jacks.

1.4.10 OUTPUT TO POWER AMPLIFIER.—Outputs from these jacks connect to the stereo power amplifier or JBL Energizer. The SG520 can drive an impedance as low as 10,000 ohms. The Graphic Controller can drive more than one amplifier or JBL Energizer. Two sets of jacks are provided for such a purpose.

1.4.11 REMOTE RELAY ACCESSORY FUSE.—This fuse has no effect on the normal operation of the SG520. It protects against an accidental short circuit which could result from improper use of

the REMOTE RELAY switch. If the fuse **should** blow, the operation of any remote control devices will be affected and hum may possibly be introduced into Channel A.

- 1.4.12 REMOTE RELAY SWITCH AND SWITCH LOCK.—Unless the JBL F22 remote relay accessory is connected to the Graphic Controller, this switch should remain in the OFF position. Should it accidentally be turned ON, the fuse described in the preceding paragraph will blow.
- 1.4.13 AC OUTLETS (SWITCHED).—The five AC outlets at the extreme right are for plugging in any device which must be turned on or off along with the Graphic Controller. These would include such components as tuners, tape recorders, power amplifiers, etc. If the system uses the JBL Solid State Energizer and does not have the F22 Remote Relay control, an extension cord can be run from one of these switched outlets to the energizer so that it will be switched off when the system is not in use.
- 1.4.14 UNSWITCHED AC OUTLET.—The single outlet to the left of the power cord is live at all times.
- 1.4.15 110-120/220-240 VOLT ADJUSTMENT (EXPORT MODEL ONLY).—On the export model Graphic Controller, there are two holes in the upper portion of the name plate on the rear panel. The hole on the left is marked 220 VOLTS and the other 110 VOLTS. The Graphic Controller is shipped with a slotted nylon screw in the 220 VOLT position. If the unit is to be operated from a 110-120 volt line, change the screw to the opposite hole.

Note that the fuse on the concealed front panel should also be changed whenever the AC line voltage is changed. For 110-120 volt operation a 0.3 amp Slo-Blo Fuse is required. For 220-240 volt operation the fuse should be changed to a 15/100 amp Slo-Blo unit.

Section 2

PERFORMANCE SPECIFICATIONS AND TESTING

2.1 SPECIFICATIONS

- 2.1.1 RATED OUTPUT.—3 volts.
- 2.1.2 HARMONIC DISTORTION AT RATED OUTPUT.—Less than 0.15%, from 20 to 20,000 CPS.
- 2.1.3 NOISE.—Less than any other preamplifier — only 1 microvolt referred to low-level phono input. From high-level inputs, 90 db below rated output.
- 2.1.4 GAIN.—Low-level inputs, 54 db; high-level inputs, 21 db.
- 2.1.5 FREQUENCY RESPONSE.—Typical response within $\pm 1/4$ db, 20-20,000 CPS (with all filters out of the circuit).
- 2.1.6 POWER CONSUMPTION.—20 watts.
- 2.1.7 TONE CONTROLS — MIN.— ± 18 db at 20 CPS; ± 16 db at 20,000 CPS. See curves in figure 3-4.
- 2.1.8 TRANSISTORS AND DIODES.—The unit contains two signal diodes, eight rectifier diodes, a zener diode, one power transistor and 22 low-level transistors.

2.2 MEASUREMENT TECHNIQUES

Most of the commonly available instruments used in testing audio amplifiers have higher distortion and/or noise than the SG520 generation by itself relative to the signal. In order of preference we recommend for the audio oscillator a Radford Low Distortion Oscillator or a Hewlett-Packard Model H20-200CD. For making IM Distortion measurements we recommend the THD measurements should be made with a Hewlett-Packard Model 333 or the Audio Instrument Company Model 168 Analyzer. Because the residual distortion, hum and noise of the SG520 is so low, the measuring techniques recommended below should be used to be sure that you are measuring the amplifier and not the test instruments.

2.2.1 TESTING HIGH LEVEL INPUTS

2.2.1.1 Total Harmonic Distortion

Step 1. Connect the oscillator to either the A or B TUNER 1 input jack with a standard shield-cable.

Step 2. Connect the harmonic distortion analyzer and 10,000-ohm, ½-watt carbon load resistor to the OUTPUT TO POWER AMPLIFIER jack of the SG520.

Step 3. Both the oscillator and the distortion analyzer should be "floated" or isolated from the power line grounding the system. This can be done by using a two-blade power plug adaptor which disconnects the instrument's power cable ground pin. If the Hewlett-Packard oscillator is used, the output transformer is floated from the instrument chassis ground. Do not connect a common ground between the oscillator and analyzer.

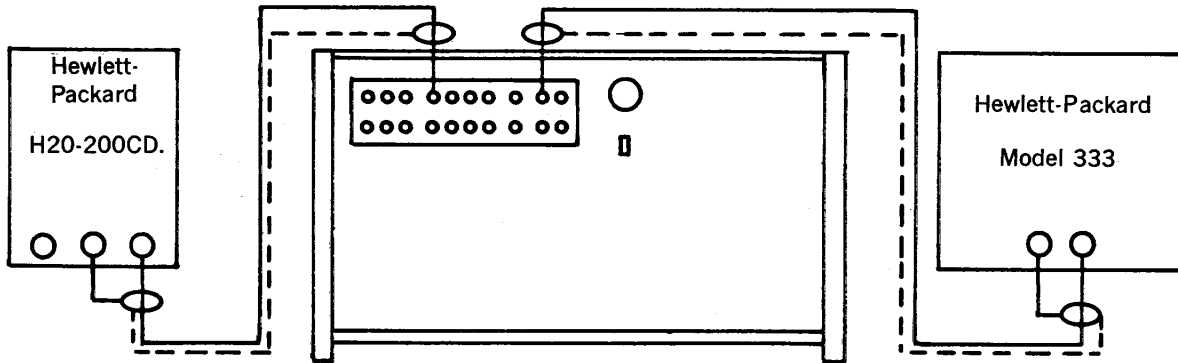

Figure 2-1 HARMONIC DISTORTION

2.2.1.2 **Intermodulation Distortion.**—In this procedure, the connection of the Audio Instrument Company Model 168 Analyzer is described because this unit is easier to use. However, the HP equipment can be used in an equivalent setup.

Step 1. Connect the OSCILLATOR OUT terminals of the intermodulation analyzer to the TUNER 1 jack with a standard shielded cable.

Step 2. Connect a 10,000-ohm carbon load resistor to the OUTPUT TO POWER AMPLIFIER jack of the SG520.

Step 3. Connect the hot ANALYZER INPUT terminal to the center output terminal of the SG520. Make no connection between the analyzer ground terminal and the common output terminal of the SG520. This precaution avoids the ground loop that would be completed through the analyzer common input-output connection.

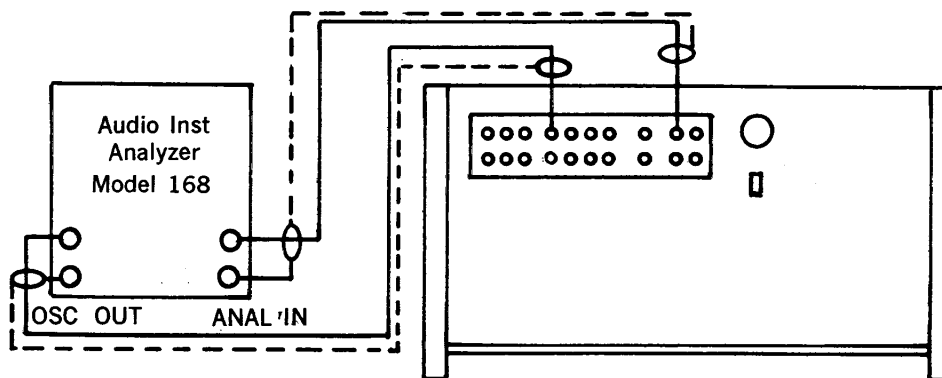

FIGURE 2-2 INTERMODULATION DISTORTION

2.2.1.3 Hum and Noise

Step 1. Connect the HP distortion analyzer or an equivalent (HP 400H) AC voltmeter to the OUTPUT TO POWER AMPLIFIER jack on the SG520.

Step 2. Terminate the desired high level input (AUX or TUNER) with a phono plug containing a 1000-ohm resistor. The resistor should have short leads to the phono plug and should be shielded by the plug body. A Switchcraft 3502 phono plug provides a convenient means to contain and shield a 1,000 ohm $\frac{1}{4}$ -watt resistor.

Step 3. Select the correct input with the SG520 SOURCE switch, slide the VOLUME control to maximum and measure the noise output on the AC voltmeter. Express the noise reading in decibels below full output (3 volts across 10,000 ohms).

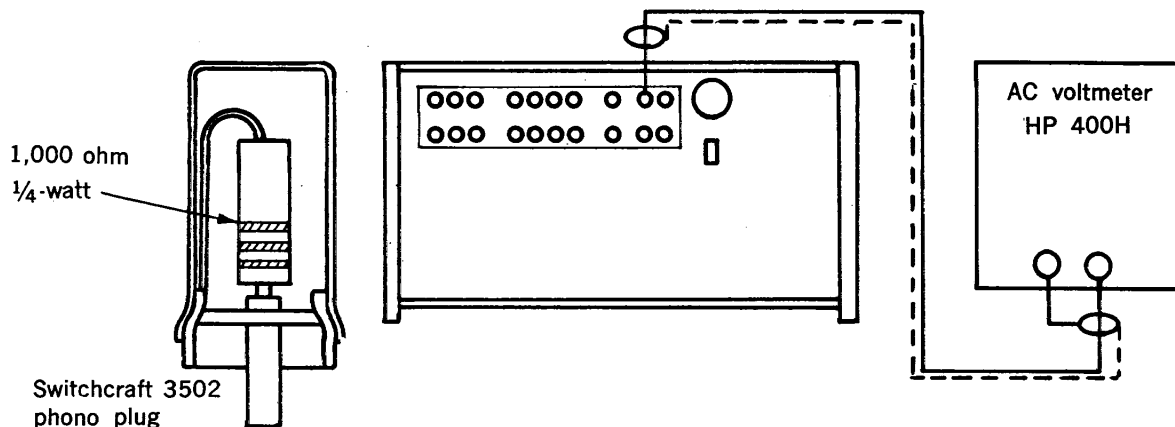

FIGURE 2-3 HUM AND NOISE

2.2.2 TESTING LOW LEVEL INPUTS

2.2.2.1 Distortion

Step 1. Use a floating oscillator and analyzer as described in the high-level distortion measuring procedures.

Step 2. If it is desired to make measurements with both channels drive simultaneously, the oscillator must be connected to the PHONO input jacks by equal length shielded cables twisted together for their full length from the oscillator to the input jacks. If this is not done, stray 60-cycle magnetic fields induce in the cable shields. The input hum signal thus generated can easily be greater than the amplifier distortion products.

2.2.2.2 **Intermodulation Distortion.**—The SMPTE* measurement technique specifies that a 4-1 ratio exists between low and high frequency test signals and is used for test of amplifiers which have uniform frequency response. The RIAA equalization used to compensate for magnetic phono cartridge and recording characteristics prevents accurate interpretation made under SMPTE test conditions.

*Society of Motion Picture and Television Engineers

2.2.2.3 Hum and Noise

Step 1. Terminate the PHONO 1 (or 2) input jack with a 1000-ohm resistor as noted previously.

Step 2. Set the SOURCE switch at PHONO 1 (or 2).

Step 3. Slide the VOLUME CONTROL all the way up and measure the noise output with the AC voltmeter. The reading may be expressed as decibels below full output or as "microvolts referred to the input." To obtain the latter figure, the output noise reading must be divided by the gain of the SG520 at 1000 CPS. The nominal low-level gain of the amplifier at this frequency is 510. The exact gain can be obtained by feeding a one millivolt signal at 1000 CPS into the PHONO input and then measuring the output with an AC voltmeter.

Section 3
CIRCUIT DESCRIPTION

3.1 OVERALL CIRCUIT.

The SG520 Graphic Controller is a transistor stereo preamplifier designed for maximum operator convenience and versatility. The circuits are somewhat complex because of the linear-actuated potentiometers, illuminated pushbutton switches, and front panel screwdriver potentiometers which provide this versatility. The stereo amplifiers are also unique, use large amounts of negative feedback in each transistor stage for consistent gain performance. A special circuit is the 1000-CPS test oscillator which is used for aural balancing. The power supply section provides —24 volts for the amplifiers and oscillator and +24 volts for the F22 accessory. Each of the circuits is described in greater detail. For ease in referencing, all components have been numbered by series:

100 series — Channel A Amplifier
200 series — Channel B Amplifier
300 series — Front Panel
400 series — 1000-Cycle Oscillator
500 series — Power Supply

Figure 3-1 is a block diagram of the complete unit. See page 26.

3.2 PREAMPLIFIER DETAILS.

Each preamplifier is contained on an individual etched-circuit board. The left channel is designated A; the right channel is designated B. Since both circuits are the same, only channel A will be described here. The description also applies to channel B when the component numbers are increased by 100 (for example, R105 becomes R205, in channel B).

3.2.1 Phono Preamplifier.—The phono preamplifier consists of three PNP transistor stages, Q101, Q102, and Q103. The preamplifier is used only with the low-level inputs for PHONO 1 (J101), PHONO 2 (J102) or MIC (J103) as selected by the SOURCE pushbutton bank.

In the TAPE PLAY, AUX FRNT, AUX REAR, TUN 1, or TUN switch positions, the preamplifier is bypassed and Q104 accepts the output of high-level sources. In the low-level (PH1, PH2, or MIC) switch position a signal of 4 millivolts will produce full amplifier output. At maximum VOLUME setting, the input sensitivity is 4 millivolts; at reduced settings, the preamplifier will not be overloaded with levels up to 250 millivolts. In both Q101 and Q102, the amount of DC degeneration is greater than AC degeneration, because the emitter load resistance is split. For example, Q102 has a total DC emitter load resistance of $R115 + R116 = 2.4k$. But its AC load is only 240 ohms, through AC bypass capacitor C114.

NOTE

The split-resistance emitter load is used in a number of preamplifier stages. When troubleshooting stages, an open bypass capacitor produces a common symptom: the ac gain has dropped to the dc gain value.

The output of the phono preamplifier is taken from the emitter of emitter-follower Q103 (PNP) and ac coupled through C117, through one of the low-level (PH1, PH2, or MIC) selector switches SW301, and through the TAPE MONITOR switch SW30 (OFF position) to the next amplifier stage, Q104. The output at the emitter of Q103 is also applied as negative feedback back to the emitter of Q101 through the networks for RIAA, NARTB, or flat response. This network has a fixed dc resistance (which sets the overall preamplifier gain), but has lower reactance at high frequencies. The resultant low-boost and high-cut response of the phono preamplifier compensates for the typical magnetic pickup response curve (figure 3-2) in either the RIAA or NARTB recording equalization method. The flat response network is used only for the microphone input. Actually, the "flat" network has a small amount of high-frequency de-emphasis (C112) which insures amplifier stability and suppresses high-frequency response beyond the audio spectrum.

3.2.2 Emitter Follower Stage Q104.—Transistor Q104 (PNP) receives its input signal from either of two sources through SW301: (1) direct from the TAPE PLAY, TUNER, or AUX jacks, or (2) output of the phono preamplifier, Q103. In either case, the nominal input level is 250 millivolts. The Q104 emitter output has a dc load is (R130), the ac load is BALANCE potentiometer, R304. The emitter follower effectively isolates the BALANCE potentiometer from the input.

3.2.3 Balance, Loudness and Volume Controls.—The channel A BALANCE control R304A is a linear sliding attenuator control which is ganged with the channel B BALANCE control R304B. When the BALANCE setting is changed, the percentage resistance increases on one potentiometer and decreases on the other. The wiper of R304A is connected to the VOLUME potentiometer R305. Both the BALANCE and VOLUME potentiometers are dual-section. The two volume control sections are matched at the factory to within 2 db tracking.

Loudness compensation is achieved by tapping the VOLUME CONTROL and shunting higher frequencies to ground, as shown in the simplified schematic, figure 3-4.

When the LOUDNESS switch is ON, capacitor C122 is placed in series with resistor R134. This causes the higher frequencies to be bypassed to ground. As shown in the diagram, most of the low frequencies are allowed to flow through the bottom terminal of the VOLUME control to ground. So, the wiper of the VOLUME control picks off more lows when it is set below the tap point. The curves in figure 3-3 show how the response varies for different VOLUME control settings. Beyond the 50 percent setting, the response is flat. Notice that the amount of high frequency de-emphasis levels off at the very high frequencies. This is the shelf level and is determined by resistor R134 which prevents the high frequencies from being completely shorted to ground.

3.2.4 Interstage Amplifier.—Transmitter Q105, (PNP) Q106 (NPN), and Q107 (PNP) are direct-coupled amplifiers which raise the audio level to provide the high level voltage gain. Negative feedback through C126 and R141 limits the ac gain of Q105, Q106, and Q107 to approximately 3. The minimum ac gain is 3 because this is the ratio of the feedback voltage divider, $\frac{R141}{R139} = 3$. The collector output of Q107 is coupled through C127 to the tone control section.

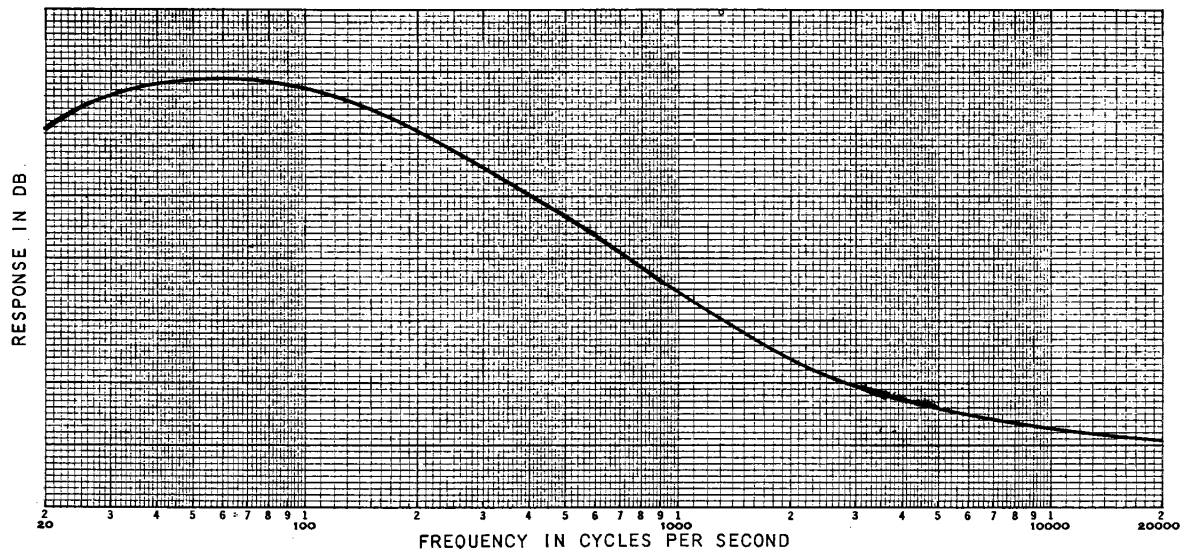

FIGURE 3-1 TAPE HEAD EQUALIZATION

3.2.5 Bass and Treble Controls.—The BASS and TREBLE controls vary the frequency at which boost or cut begins. For lowest possible distortion, tone control equalization is achieved by feedback rather than passive networks. Figure 3-4 shows the equivalent circuit of the tone control network and amplifier. When the tone controls are set in a flat position, the overall circuit gain is one.

Transistors Q108, Q109, and Q110 comprise the tone control amplifier. The output (emitter of Q110) is fed back to the input (base of Q108) through the tone control network and is summed with the audio from stage Q107. As shown in figure 3-5, the BASS control varies the frequency at which the low boost or cut begins. The **slope** of the equalization curve is relatively constant. The TREBLE control varies the amount of high boost or cut rather than frequency. The output of Q110 is applied through a scratch filter to the external power amplifier and has a nominal level of 3 volts rms for maximum output.

3.2.6 **Scratch Filter.**—When the front SCRATCH FILTER switch SW06 is on, capacitor C136 and L101 form a low-pass filter directly at the output. This network attenuates only the higher frequencies, at about 8 kc. When SW06 is OFF, the series inductor (L101) has virtually no effect on the output.

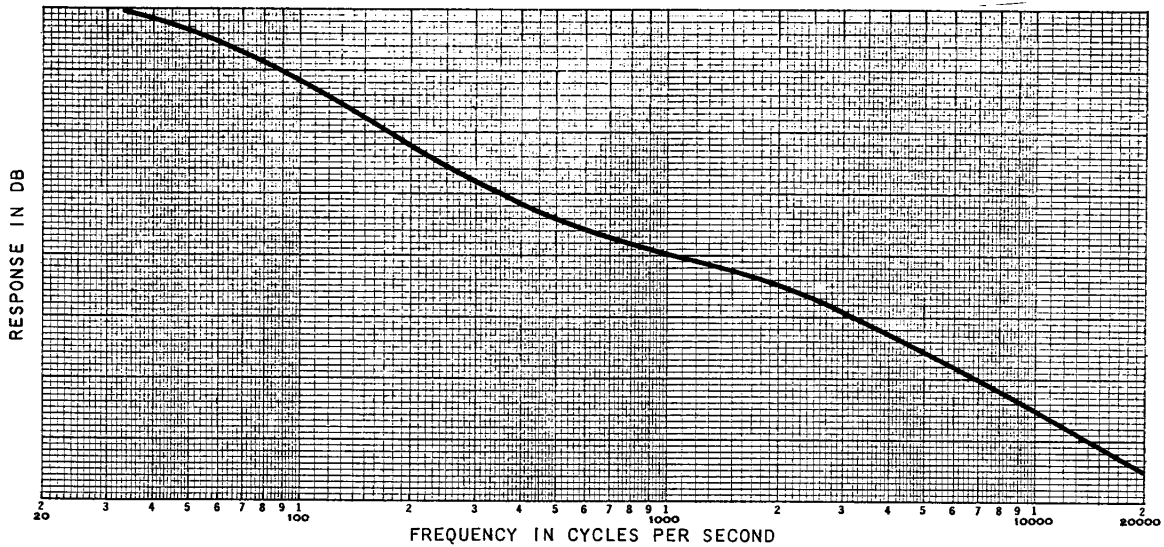

FIGURE 3-2 MAGNETIC PHONO EQUALIZATION

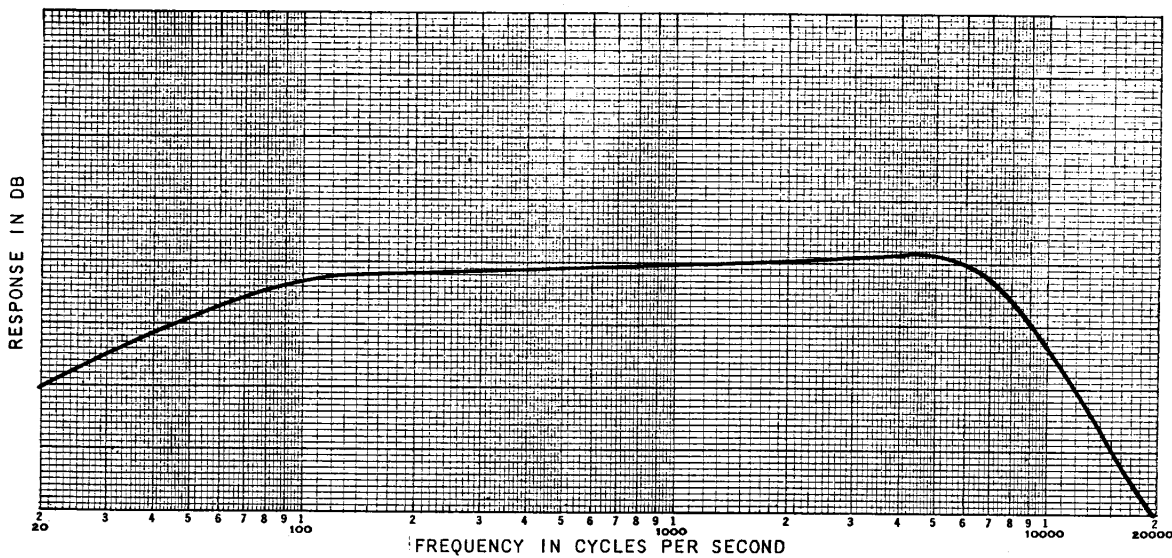

FIGURE 3-3 RUMBLE AND SCRATCH FILTER RESPONSE

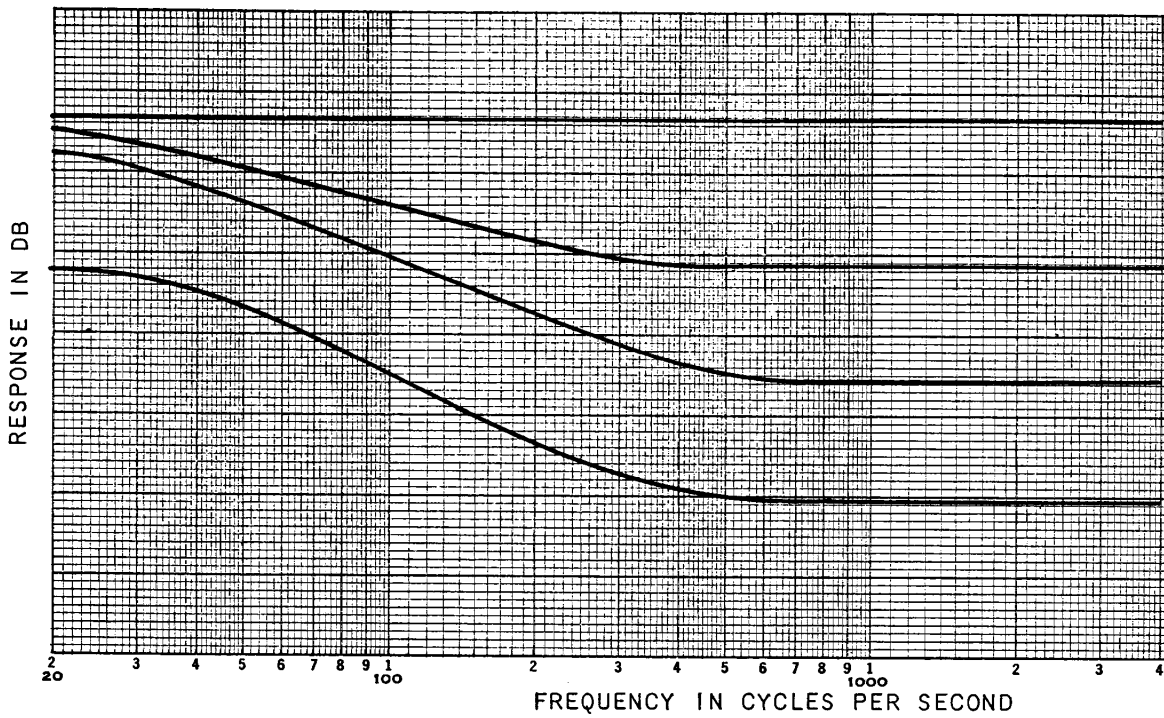

FIGURE 3-4 LOUDNESS COMPENSATION

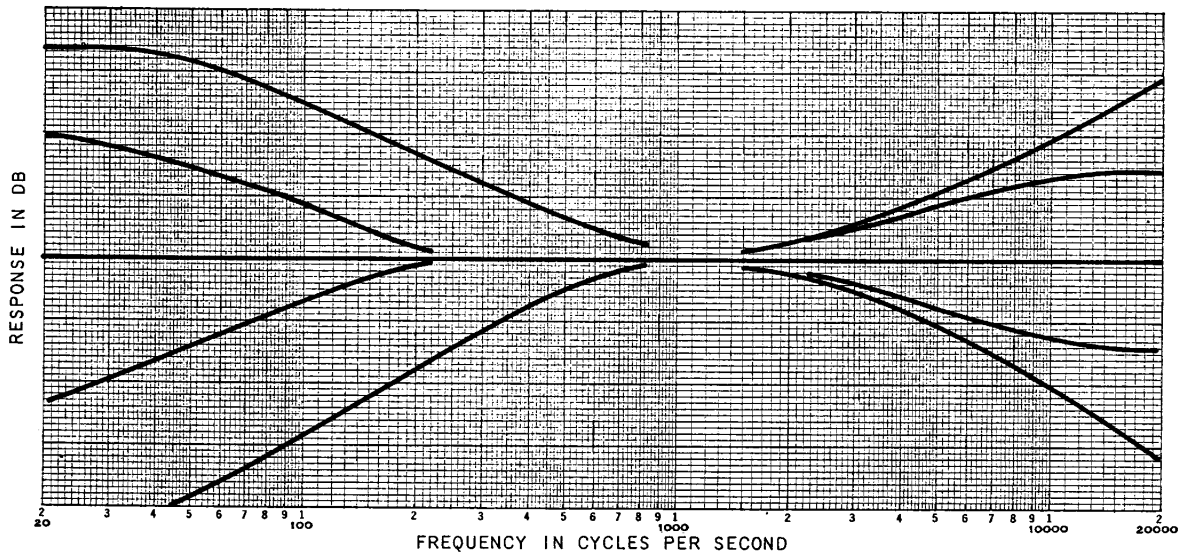

CHART NO. S-501-D (50)

FIGURE 3-5 TONE CONTROL

3.3 OSCILLATOR DETAILS

The 1000-cycle test oscillator is contained on an individual circuit board which is powered from the regulated —21-volt supply. The circuit consists of transistor Q401 (PNP) connected as a common-collector oscillator. In this oscillator the feedback is between the base and emitter. The collector does not carry a signal.

The oscillator frequency is determined by toroid L401 and capacitor C402 which tune to approximately 1000 cps. Because transistor Q401 has no ac voltage gain, the inductor L401 is driven by the emitter and tapped (an autotransformer) to provide in-phase feedback to the base which is a larger voltage than is supplied by emitter. The circuit therefore depends on the transistor's current gain to sustain oscillation. The output is taken from the emitter.

Potentiometer R401 (TEST TONE LEVEL) is used to set the output sine-wave to a level of 0.25 volts rms. Diodes D401 and D402 are clippers which limit the oscillator drive.

3.4 POWER SUPPLY DETAILS

The power supply has two outputs: +24 volts, which is unregulated, and —21 volts regulated. Bridge rectifier D502-D505 supplies +24 volts through an RC ripple filter. Bridge rectifier D506-D509 supplies approximately —24 volts which is dropped to —21 volts by the series regulator. Power transistor Q501 (PNP) is the pass regulator. The output remains constant since the normal base emitter drop is nearly constant over a wide current range. The emitter follows the base which in turn follows the base of driver Q502. The base of Q502 is referenced to —22 volts across zener diode D501. So, if the line voltage (or load current) varies, the Q501 emitter remains at —21 volts.

Section 4

REPAIR AND ADJUSTMENT

4.1 SYSTEM TROUBLESHOOTING

Amplifier problems reported by the owner of an elaborate stereo system can often be traced to factors outside the amplifier. Unlike vacuum tube amplifiers, the SG520 Graphic Controller is normally not subject to gradual deterioration or intermittent hum and noise problems. In fact, the solid state circuits have proven so reliable that the entire stereo system should be checked before bringing the SG520 into the shop. Table 4-1 gives some hints for troubleshooting the system. These checks require only a few minutes to perform.

4.2 AMPLIFIER DISASSEMBLY AND SERVICE

After isolating any malfunctions to either of the amplifier circuit boards, disassemble the unit as explained below. Note that the channel A amplifier is on top (figure 4-1) and may not have to be removed.

4.2.1 Top and Bottom Cover Removal

Step 1. Using #2 (or #1) Phillips screwdriver, remove five screws which secure top cover to cabinet. Lift cover away.

Step 2. Repeat for bottom cover. The unit is now accessible for service to the units shown in figure 4-1.

TABLE 4-1 TROUBLESHOOTING

Trouble Symptom	Remedies
A. Entire graphic controller inoperative. Pushbuttons do not glow.	<ol style="list-style-type: none"> 1. Check fuse under hinged panel. Replace with correct rating, slo-blo. 2. Suspect wiring of power switch and power transformer. 3. Export model: check voltage selection.
B. Pushbuttons glow, but unit has no program output on either channel (no noise is heard with maximum VOLUME on MIC channel).	<ol style="list-style-type: none"> 1. Press stereo (S) MODE pushbutton and set TEST TONE switch ON. Is 1000-cycle tone heard? If not, refer to symptom C. If only in one channel, trouble is in line amplifier portion of faulty channel. If tone is heard in both channels, refer to symptom D.
C. Pushbuttons glow, but unit has neither program audio or test tone output.	<ol style="list-style-type: none"> 1. Faulty —21-volt power supply. 2. Faulty line amplifier in both channels. 3. Faulty MODE switch or wiring. 4. Faulty low-level amplifiers plus faulty oscillator (symptom E).

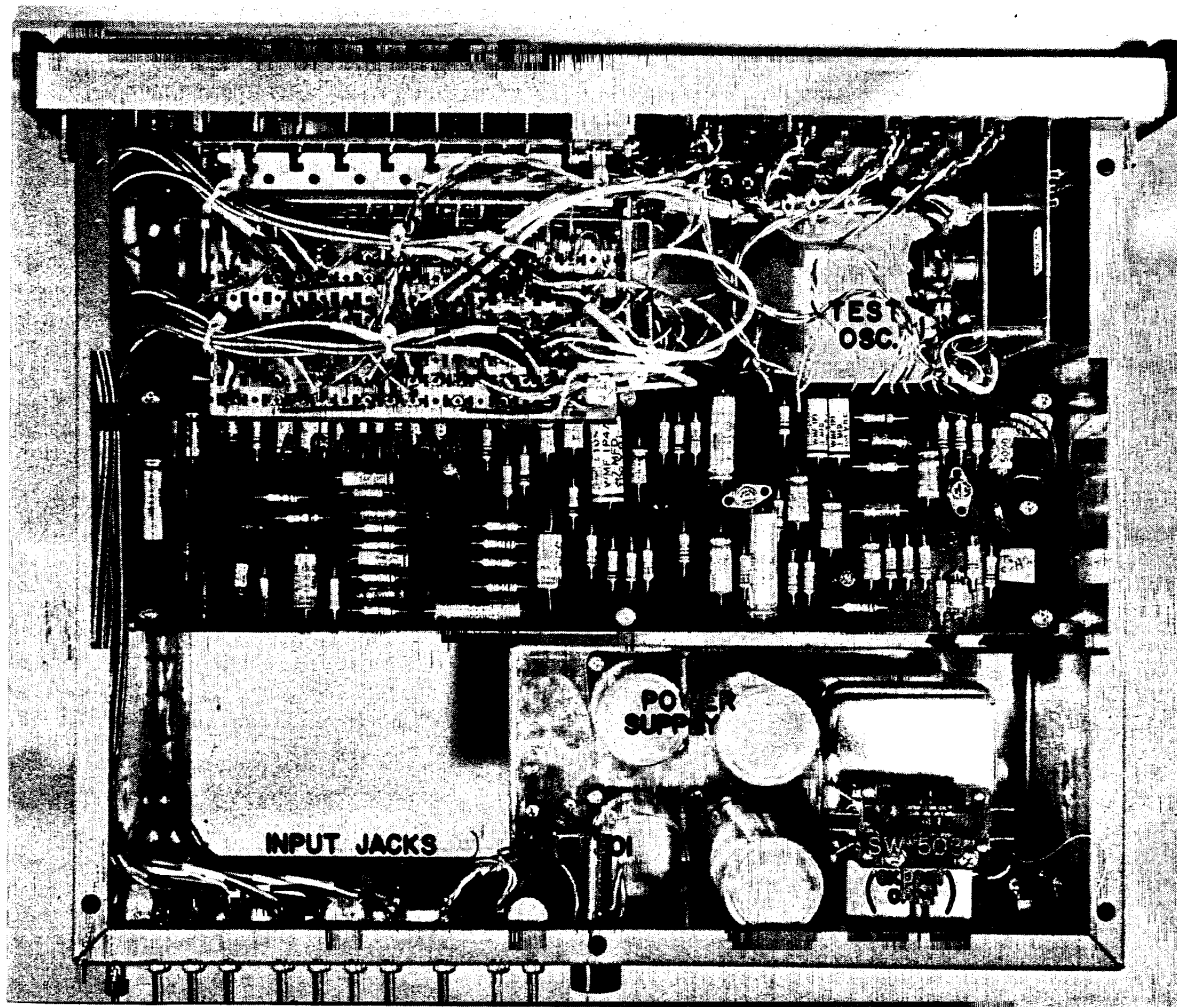

FIGURE 4-1 TOP VIEW

D. Test tone is OK, but program audio is dead.

1. Interchange program audio between each of the low-level (PH1, PH2, or MIC).

If all inputs are dead, trouble is in the low-level (Q101-Q103) portion of the amplifier board (or the TAPE MONITOR switch is on).

2. Program audio is dead. Check for faulty connections to phonograph pickup, bad cartridge, or faulty tape read head.

E. Test tone not heard.

1. Faulty test oscillator. To make sure, set TEST TONE switch ON and connect headphones (or a small loudspeaker) to either of the front panel OUT TO RECORDER jacks. Then press the TEST and S buttons at the same time. If the test oscillator is operating, the tone should be heard.

F. No stereo effect
(MODE switch S
button is depressed).

1. Slide BALANCE control to either extreme. If one channel is not operating, refer to B and C above.

2. If both channels are operating, check for any condition which could cause channel mixing such as defective system cabling, cartridge, multiplex tuner, or tape deck.

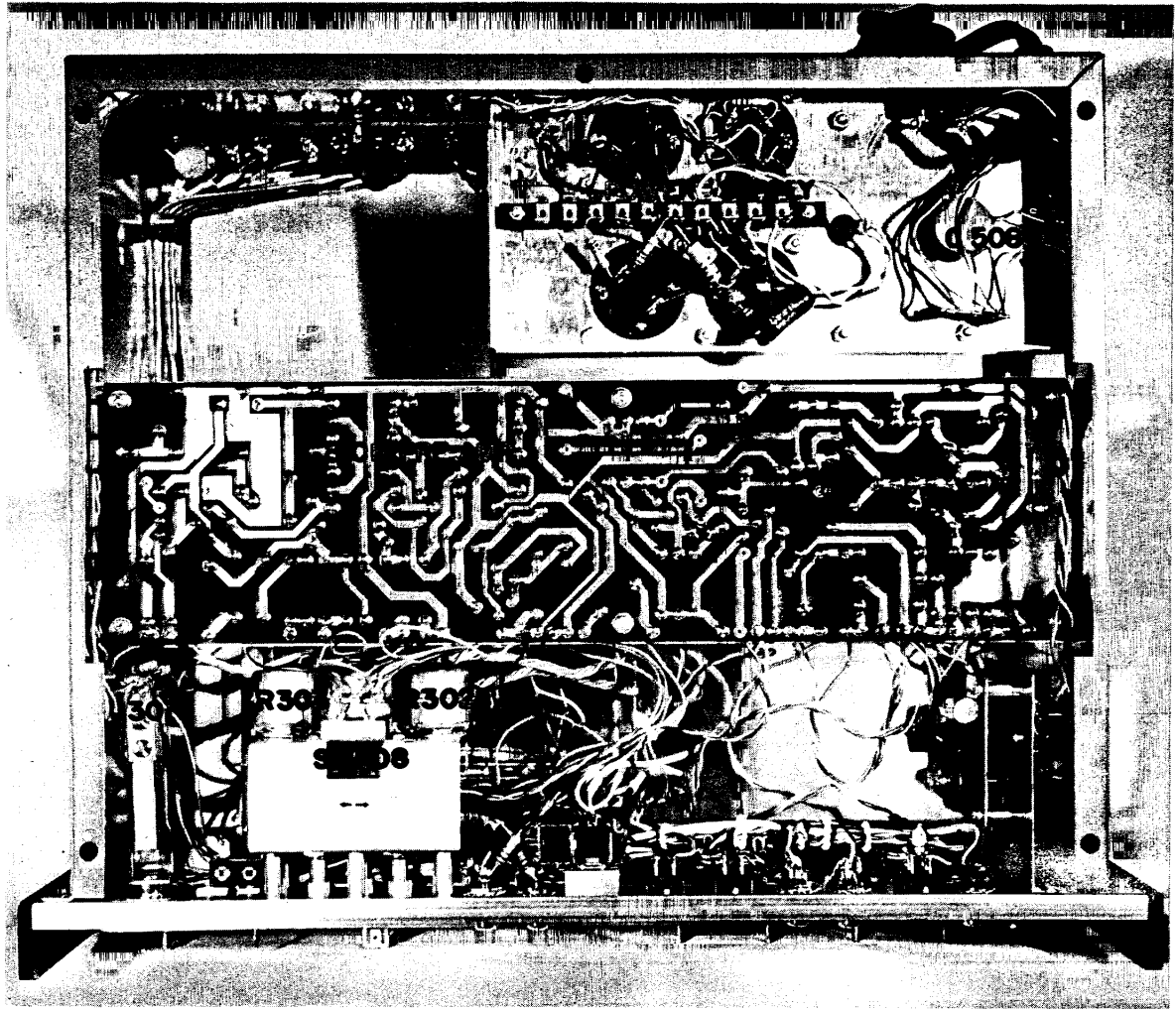

FIGURE 4-2 BOTTOM VIEW

G. Hum in system.

3. If program source is at fault, look for wrong stylus pressure, improper tape player head alignment or improper multiplex. F-M tuning.

1. Check interconnecting cables for proper shield bonding to plugs.
2. Connect #18 ground wire between the amplifier GROUND post and the system tape deck or turntable motor frame.
3. Move SG520 away from power amp, which may have stray magnetic field.
4. Check SW307, F-22 switch and fuse F301.
4. Check —21-volt regulator.
5. Suspect ripple in amplifier power supply due to faulty electrolytic filter capacitor.
6. If hum still exists in a complex system installation, connect the system GROUND to a true earth ground (cold water pipe, etc.).

4.2.2 **Channel A Service.**—The channel A amplifier circuit board is accessible from the top of the cabinet. To test channel A, proceed as follows:

Step 1. Connect an audio signal generator to the A PHONO 1 jack. Set the level to approximately 10.0 millivolts @ 1 kc.

Step 2. Press the PH1 button and apply power.

Step 3. Using an accurate electronic ac voltmeter (HP Model 400 recommended), trace the signal level at each stage of the amplifier. Refer to figure 4-9 which shows the component locations.

Step 4. Refer to the troubleshooting chart, table 4-1, when a signal fault is encountered.

Step 5. When a faulty component is found, refer to paragraph 4.4 for replacement recommendations and to Section 5 for parts list.

4.2.3 Channel B Service.—The channel B amplifier must be removed for service. Turn ac power off. Proceed as follows:

Step 1. Using a #2 (or #1) Phillips screwdriver, remove six 6-32 screws which secure the channel B circuit board to its chassis.

Step 2. Lift three power leads (red, grey, black twisted together) out of the way. Then lift the channel B circuit board up.

Step 3. Tilt the circuit board up to a vertical position and tuck a few strips of paper under the edge to insulate the edge connections from the chassis.

Step 4. In this position, apply power and test the circuits as explained in paragraph 4.2.2, for the A channel. Refer to table 4-2 for troubleshooting.

4.3 TEST TONE OSCILLATOR DISASSEMBLY AND SERVICE

When the test tone oscillator is known to be inoperative, service it as follows (it is not necessary to remove the front panel):

Step 1. Lay the chassis on its side panel, with the oscillator board components facing up.

Step 2. Using a #2 (or #1) Phillips screwdriver, remove four 6-32 screws which secure the oscillator circuit board to its subpanel.

Step 3. Lift the circuit board out into the clear. The leads are long enough to allow the board to be placed on the bench for testing.

Step 4. Refer to the troubleshooting suggestions in table 4-3, and to figure 4-3 for component locations and test point.

NOTE If the transistor and voltages appear OK, but the circuit does not oscillate, the trouble is probably one of the three capacitors in the circuit.

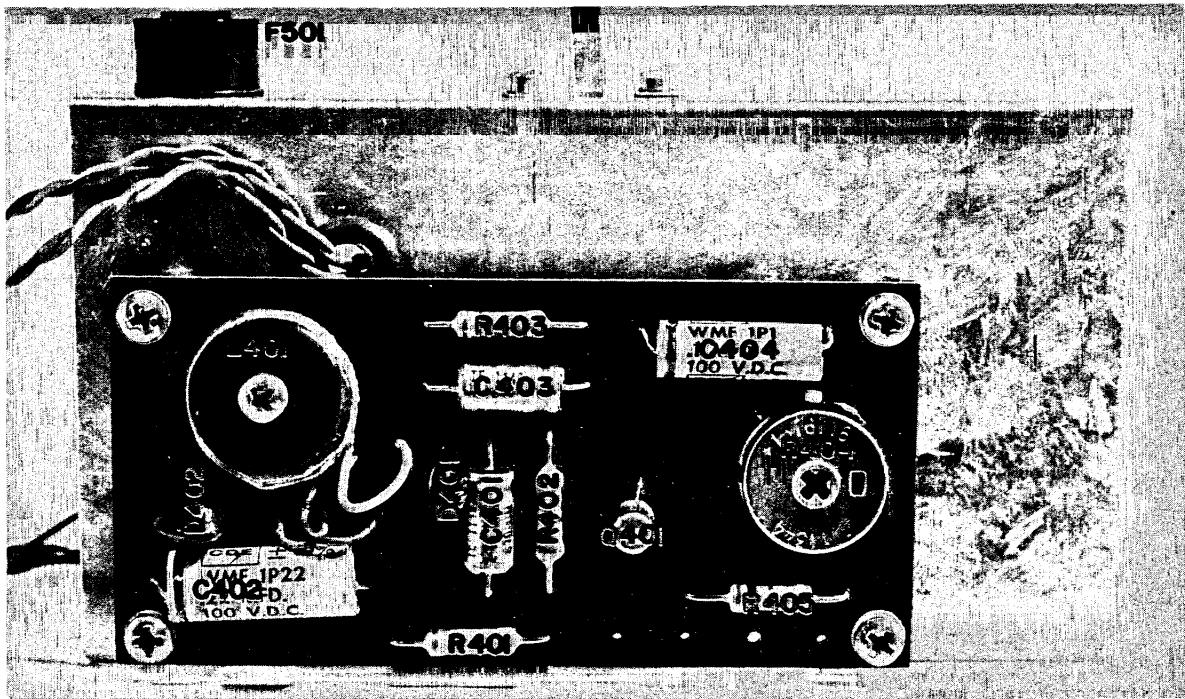

FIGURE 4-3 TEST TONE OSCILLATOR

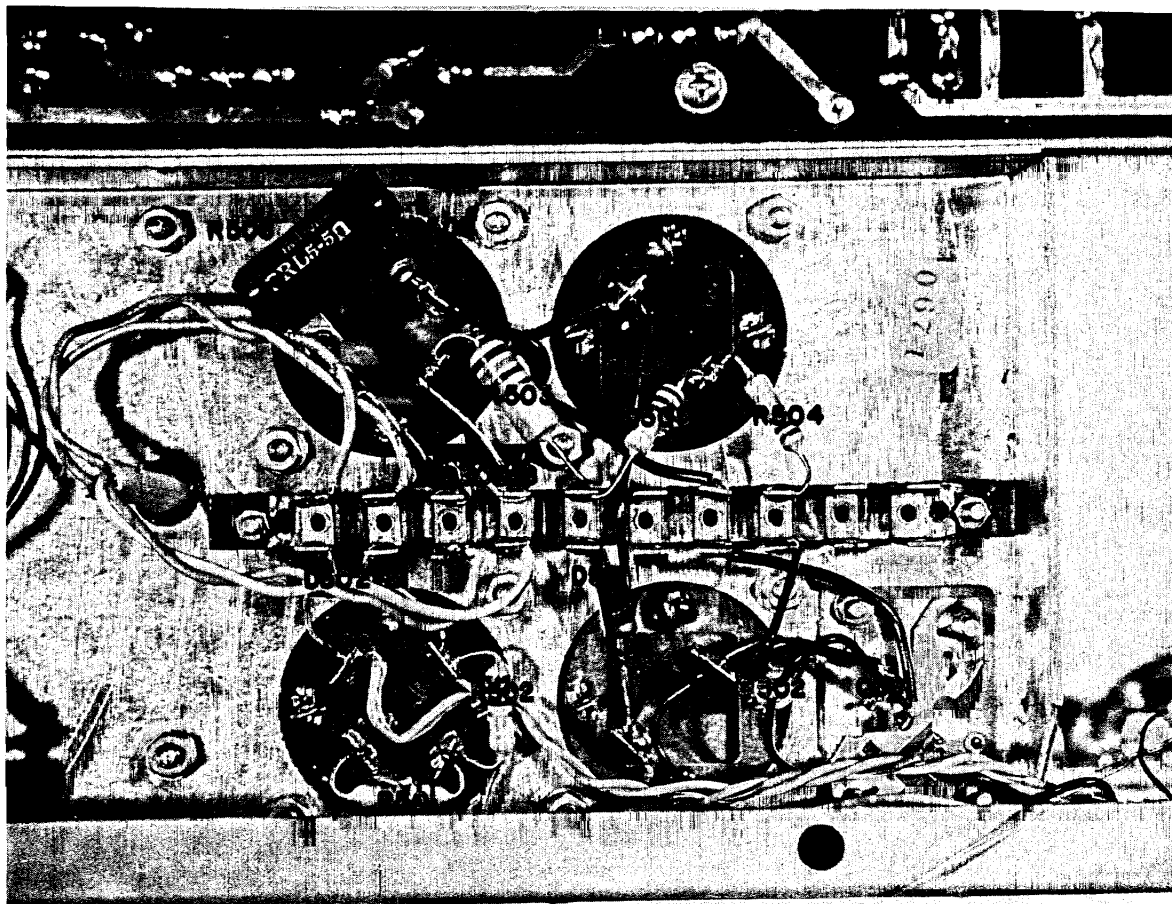

FIGURE 4-4 POWER SUPPLY

Trouble Symptom

A. Pop or thump during turn on or off.

B. Low output level from low-level portion (Q101-Q103).

C. Low output level from line-amplifier portion (Q104-Q110).

D. No output.

Remedies

1. Adjust A-C switch and output shorting switch contacts. Short on SW 501 ab. should be maintained while switch SW 501 C in either direction (see figure 4-8).

1. Voltage gain at 1 kc should be **42-44**. If less, suspect open bypass capacitors.

1. Voltage gain at 1 kc should be **3-12**. If less, suspect open bypass capacitors.

1. Using a 20,000 ohms-per-volt meter, verify that at least 1 volt dc exists between the collector and emitter of each transistor. If the voltage is near zero, transistor is shorted and must be replaced.

2. Check each coupling capacitor by measuring ac signal level at each side of the capacitor. A greatly reduced signal indicates an open capacitor.

NOTE When applying a test signal, make sure that level does not exceed 0.25 volt.

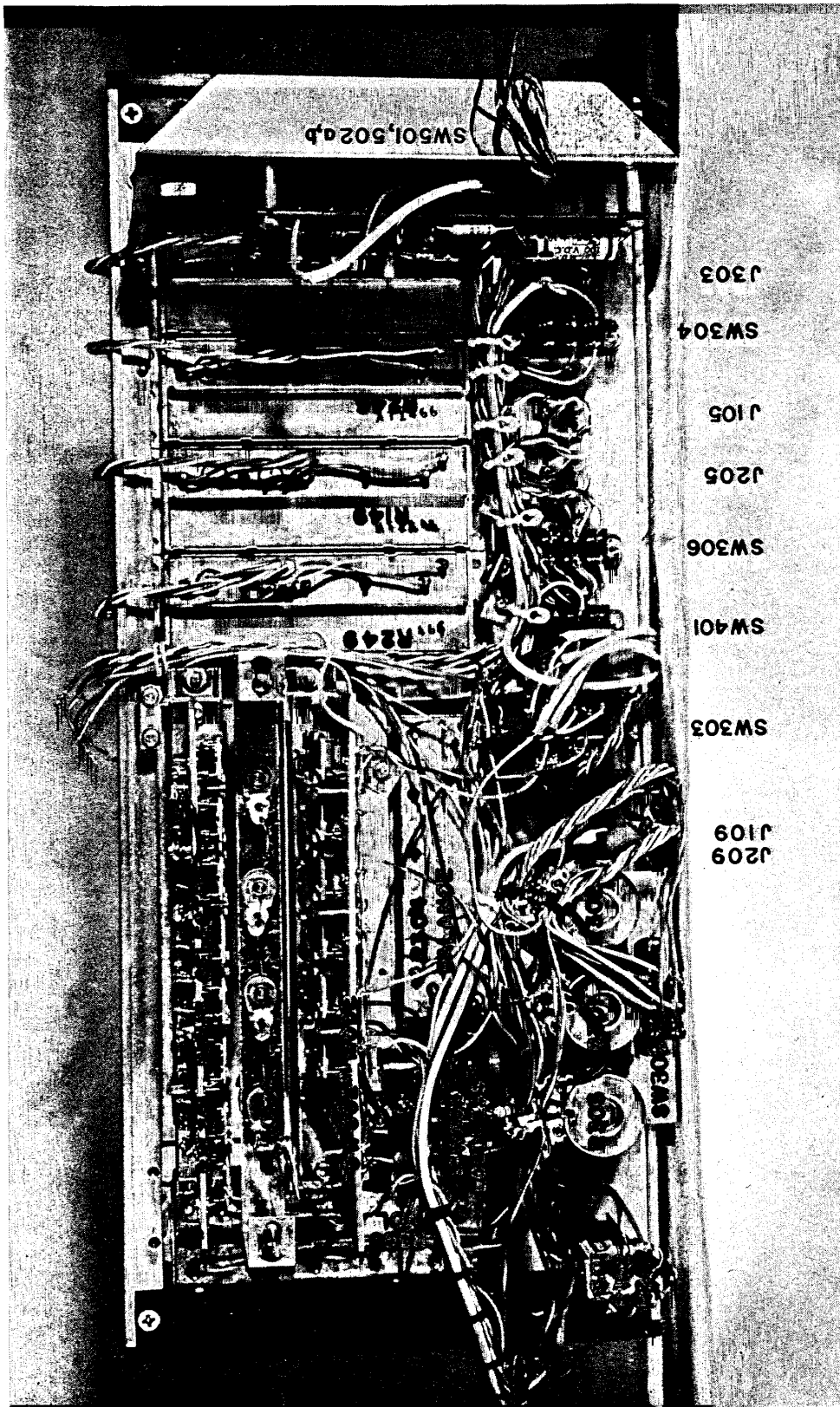

FIGURE 4-5 FRONT PANEL COMPONENTS

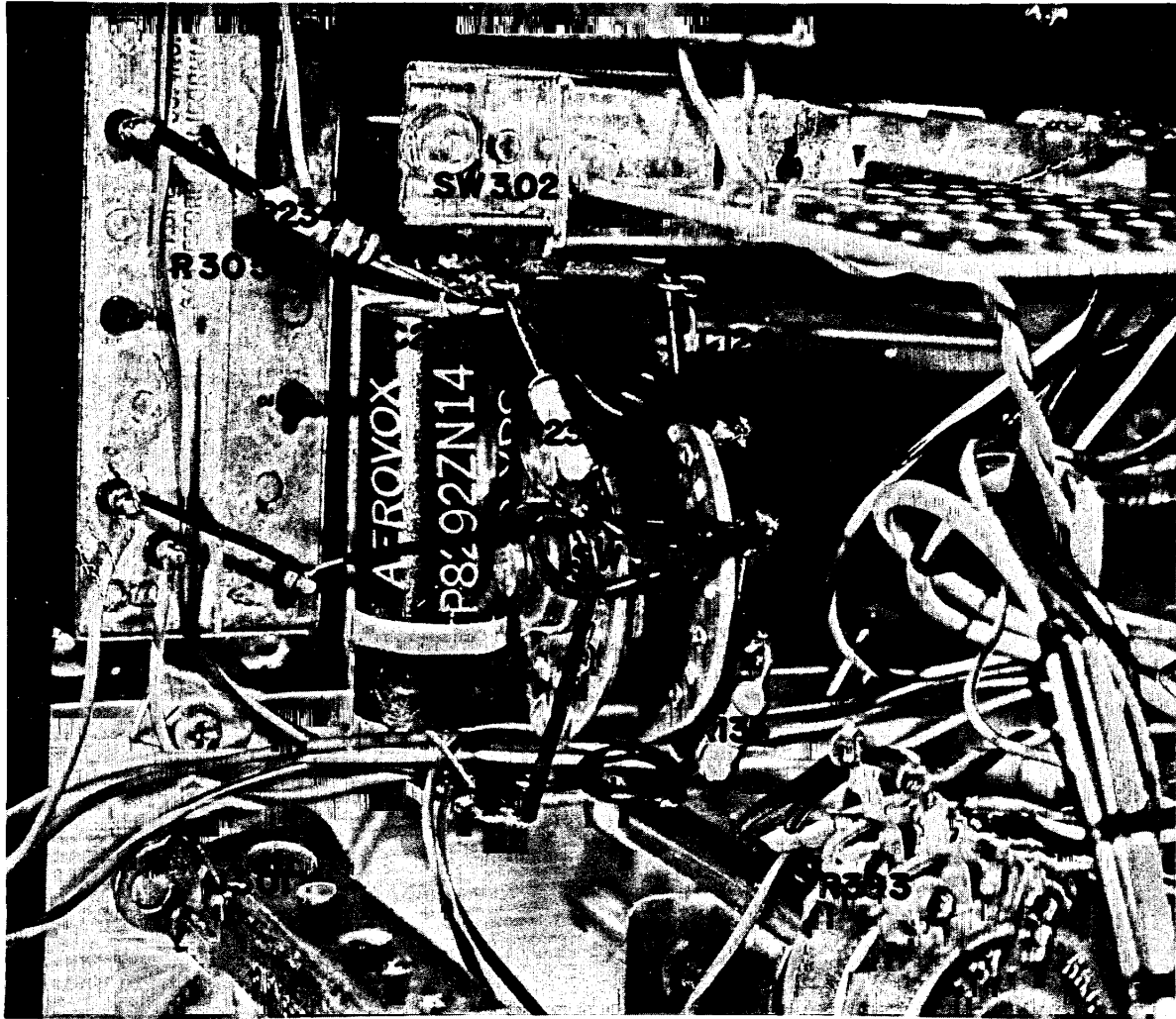

FIGURE 4-6 FRONT PANEL DETAIL

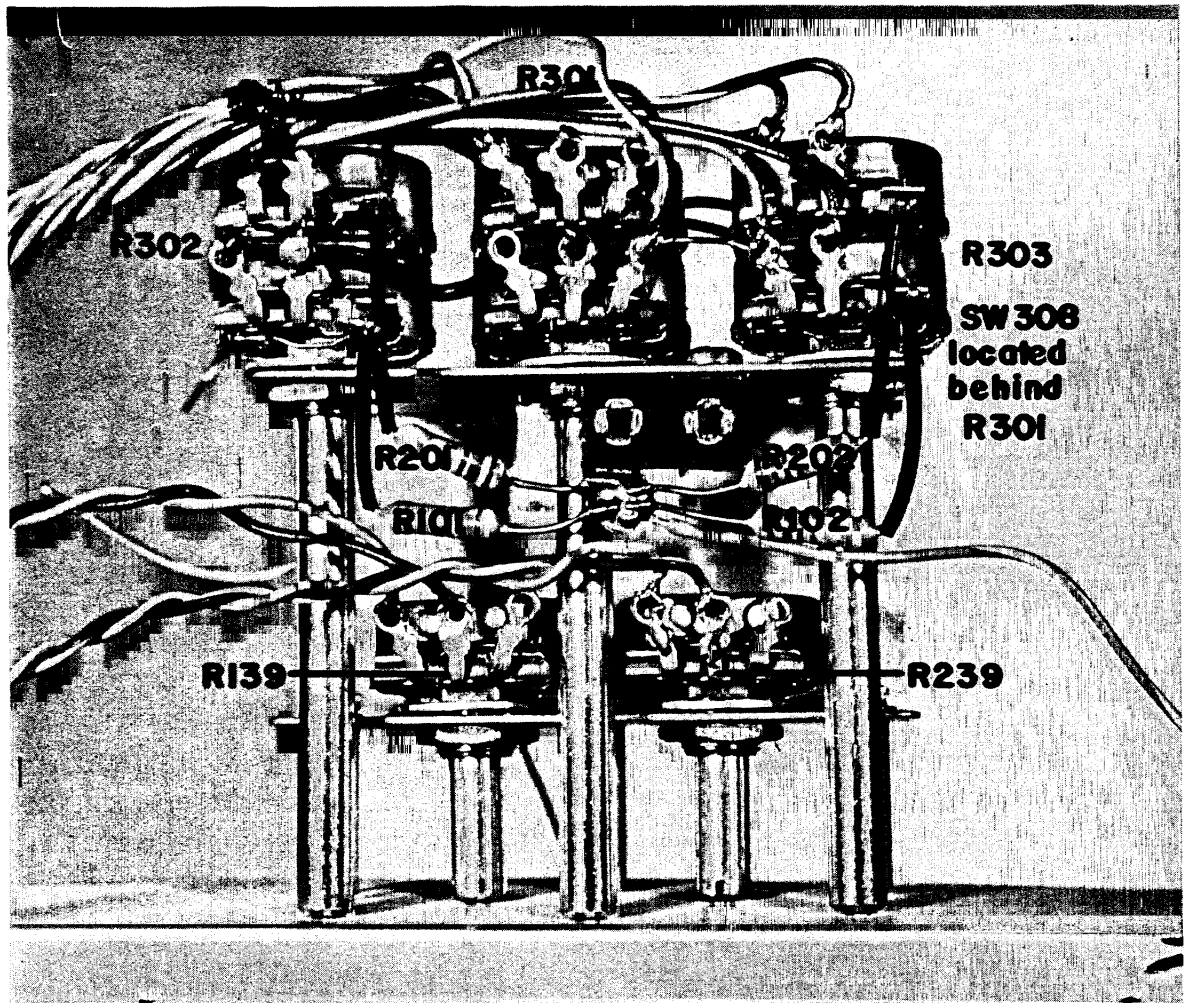

FIGURE 4-7 SECONDARY FRONT PANEL CONTROLS

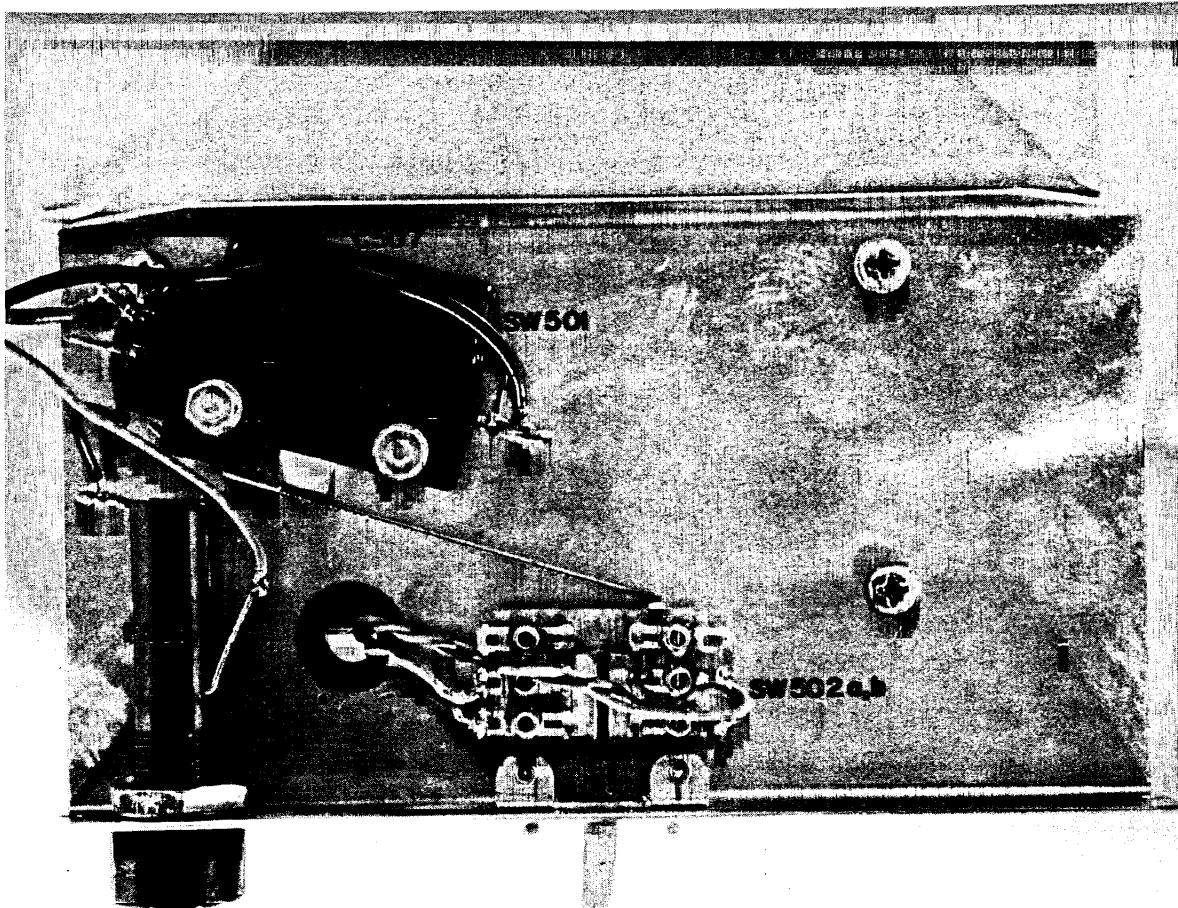

FIGURE 4-8 AC AND OUTPUT SWITCH DETAILS

Trouble Symptom

A. Low 1-kc tone amplitude (at input to Q104).

B. No Oscillation.

Remedies

1. Faulty coupling capacitor C404 or bypass capacitor C401. Check and replace if necessary.

1. Faulty transistor, Q401.

2. Open capacitors C402 or C403.

3. No power. Make certain that —21-volt power is supplied through TEST switch contacts.

4. Open potentiometer R504.

5. As a last resort, suspect toroid L401 and check it on a Q meter or inductance bridge. If it has a shorted turn, the inductance and Q will be low.

4.4 POWER SUPPLY SERVICE

To test the power supply, lay the SG520 chassis on its top. All components of the power supply are readily accessible and are shown in figure 4-4. With power applied, measure all of the voltages and compare them with the voltages shown in figure 4-4.

4.5 FRONT PANEL DISASSEMBLY

To remove the front panel, lay the SG520 chassis on its side and remove three screws on each side of the panel (at rear of trim strip). Carefully lower the front panel to a near horizontal position. The wires are not long enough to allow the panel to be pulled clear of the chassis so all panel repairs must be carefully made to prevent wire breakage. Panel components are identified in figures 4-5, 4-6, 4-7.

4.6 PUSHBUTTON SERVICE

The pushbutton banks can be subject to intermittent contact closure. This condition may be due to either (1) an accumulation of oxide on the contacts or (2), loss of contact wiping pressure. To correct condition (1), spray on a contact cleaner such as G-C type 8666 Spra-Kleen. To increase wiping pressure, use a pair of needle-nose pliers to bend the stationary contacts together. This can be done by twisting each contact half inward.

4.7 Replacement of Resistors and Capacitors.—Resistors and capacitors on the circuit boards must be replaced as follows:

Step 1. When a component is suspected, clip one of the leads at midpoint to remove it from the circuit.

Step 2. Check the component.

Step 3. If faulty, clip the other component lead at midpoint.

Step 4. Loop the new component leads over the old stub leader and solder.

CAUTION

DO NOT APPLY HEAT DIRECTLY TO THE PRINTED CIRCUIT BOARD. THIS MAY CAUSE CIRCUIT FOIL TO LIFT FROM THE BOARD.

F22 RELAY—CIRCUIT DESCRIPTION AND OPERATION

The DC activating signal for the F22 relay is applied between the chassis ground of the SG520 preamplifier and the shield connection of the channel A output cable. Although the shield of the channel A cable operates at ground potential for the AC signal, a DC potential of about ± 20 volts between the CHA shield and the chassis ground. The polarity of the DC signal determines the mode of operation of the two relays.

The AC power relay, Ry1, is connected through a full wave bridge, Dz, so that a DC signal of either polarity will energize the relay. The 500 MFD capacitor, C1, supplies enough delay so that any momentary interruption in voltage as the polarity is reversed will not cause the relay to drop out.

The stereo balance relay is connected through a single diode, D1, so that it is polarity-sensitive. The relay operates **only** if there is a positive DC voltage at the channel A ground connection.

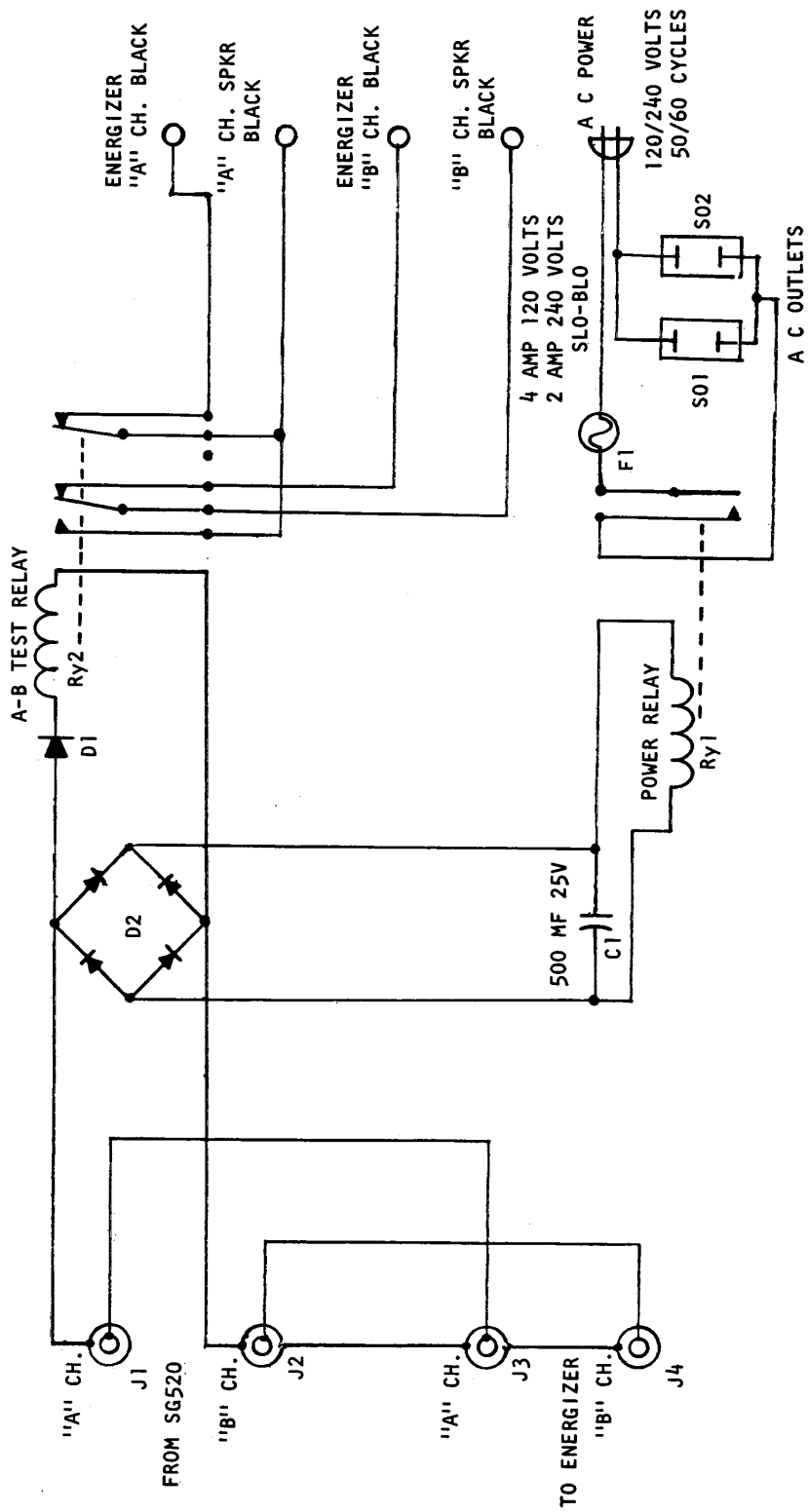

FIGURE 4-9 F22 SCHEMATIC

When the Graphic Controller is first turned on, a control signal of —20 volts appears at the shield of the channel A output. This operates the AC power relay to turn on the Energizer or power amplifier. The A-B relay, Ry2, is not actuated because of the series diode. Tracing the connections through the A-B relay contact, indicates that both loudspeakers are connected in the normal manner exactly as if the relay were not in the circuit at all.

When the Graphic Controller "test" pushbutton is depressed, the polarity of the control signal is reversed so that a +20 volt signal appears at the shield of channel A. The AC power relay remains closed and the A—B relay is now actuated. If you will trace the connections through the contacts Fig. 3-3, you will find that both of the Energizer black output terminals have been disconnected and the speakers are now connected in series between the two red Energizer output terminals. This effectively causes the speakers to respond only to an A—B or difference signal, enabling the aural null feature to be used.

When trouble-shooting the operation of the F22, remove the cover and see if the two relays are operating as described Fig. 3-2. In other words, whenever the Graphic Controller is turned on, the armature of the power relay should be pulled in, but the A—B relay should not be affected. When the test button is depressed, the power relay should remain pulled in and the A—B should also be actuated. If the two relays seem to be operating properly, then the only possible source of trouble in the system is in the connections between the A—B relay, the loudspeakers, the power amplifier or Energizer. On the other hand, if the relays are not actuated in the proper sequence, can check the operating voltage and polarity with an ordinary voltmeter.

NOTE: That it is vitally important that the shield of the channel cable be continuous, and that it not be connected to the chassis.

Section 5

REPLACEMENT PARTS AND SCHEMATICS

5.1 REPLACEMENT PARTS.

Replacement parts for the SG520 Graphic Controller are listed in the following pages. It is recommended that only JBL replacement parts be used in this high-quality amplifier.

5.1.1 **Resistors.**—All resistors are the deposited carbon film type. Any failures should be replaced with the same type. *Ordinary molded composition carbon resistors must not be used. Replacements are available directly from JBL.

5.1.2 **Capacitors.**—Most of the electrolytic capacitors used in the SG520 are specially made. Replacements should be ordered directly from JBL by part number or reference number. Under no circumstances should inferior-rated electrolytics be substituted. Lower capacities in any circuit will impair performance. Lower working voltage ratings will cause premature failure. Capacitors have been selected for low-noise specifications.

*Technicians who are familiar with professional or military dc amplifiers will remember that carbon resistors can be more noisy and have a greater resistance change with temperature.

5.1.3 **Transistors.**—All transistors are selected for current gain, low noise, and other important characteristics. Experience has shown that the current gain (β) from one transistor to the next in any production batch varies so much that sometimes one will not work well in the circuit. For this reason, all transistors carry special part numbers and must be ordered from JBL. Note the color code dot when ordering.

5.2 INFORMATION SERVICE.

Information on parts and service tips can be obtained from the JBL factory Service Department. Write a letter explaining any unusual problem to:

JBL
Service Department
3249 Casitas Avenue
Los Angeles, California 90039

If it is necessary to return a faulty subassembly or the complete amplifier, first request shipping permission. Then pack the equipment in an over-size carton, completely surround it in cushioning material, and ship by Railway Express or truck express. Be sure to insure the shipment and prepay the shipping charges. Mark the carton: Fragile — Delicate Electronic Equipment.

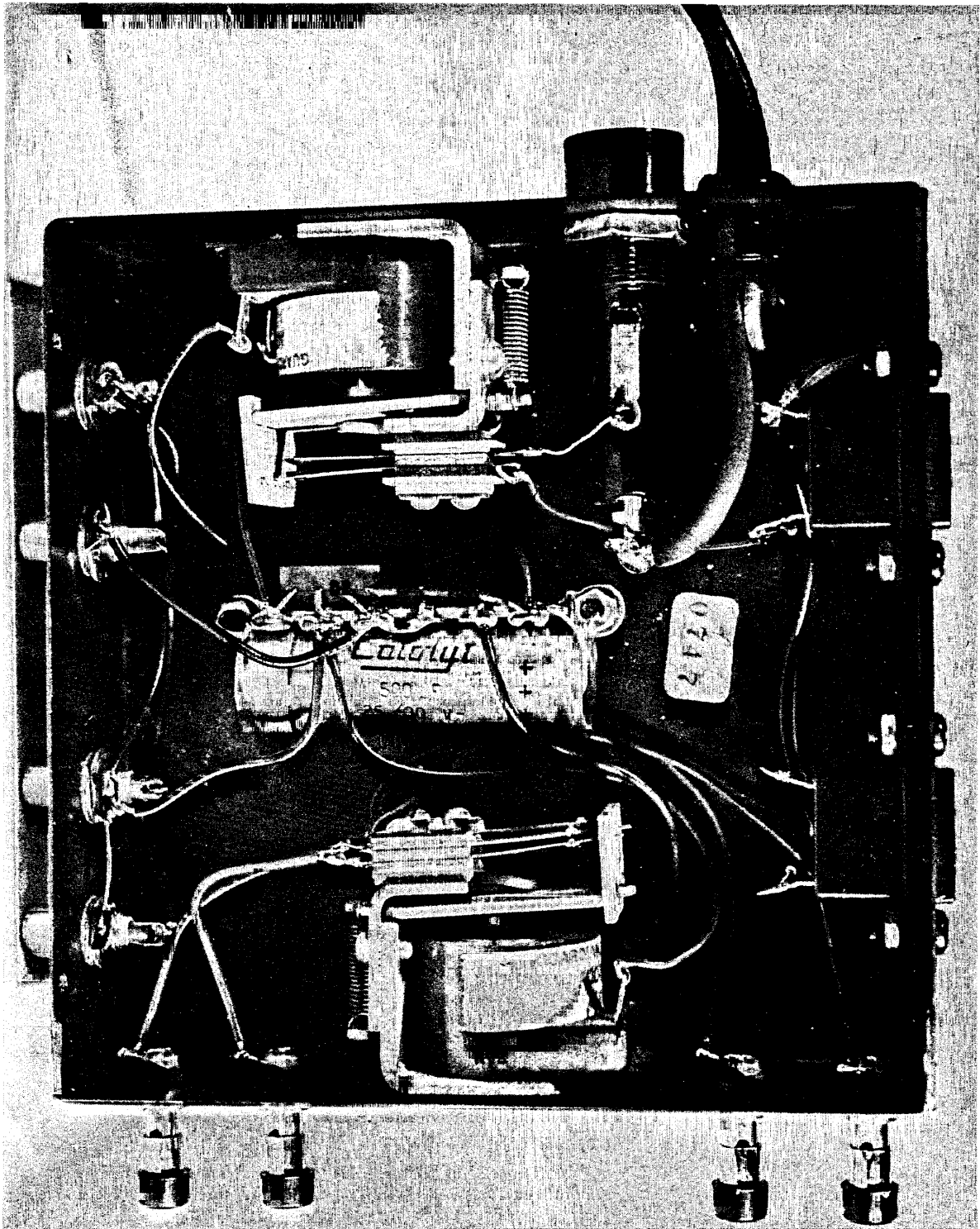
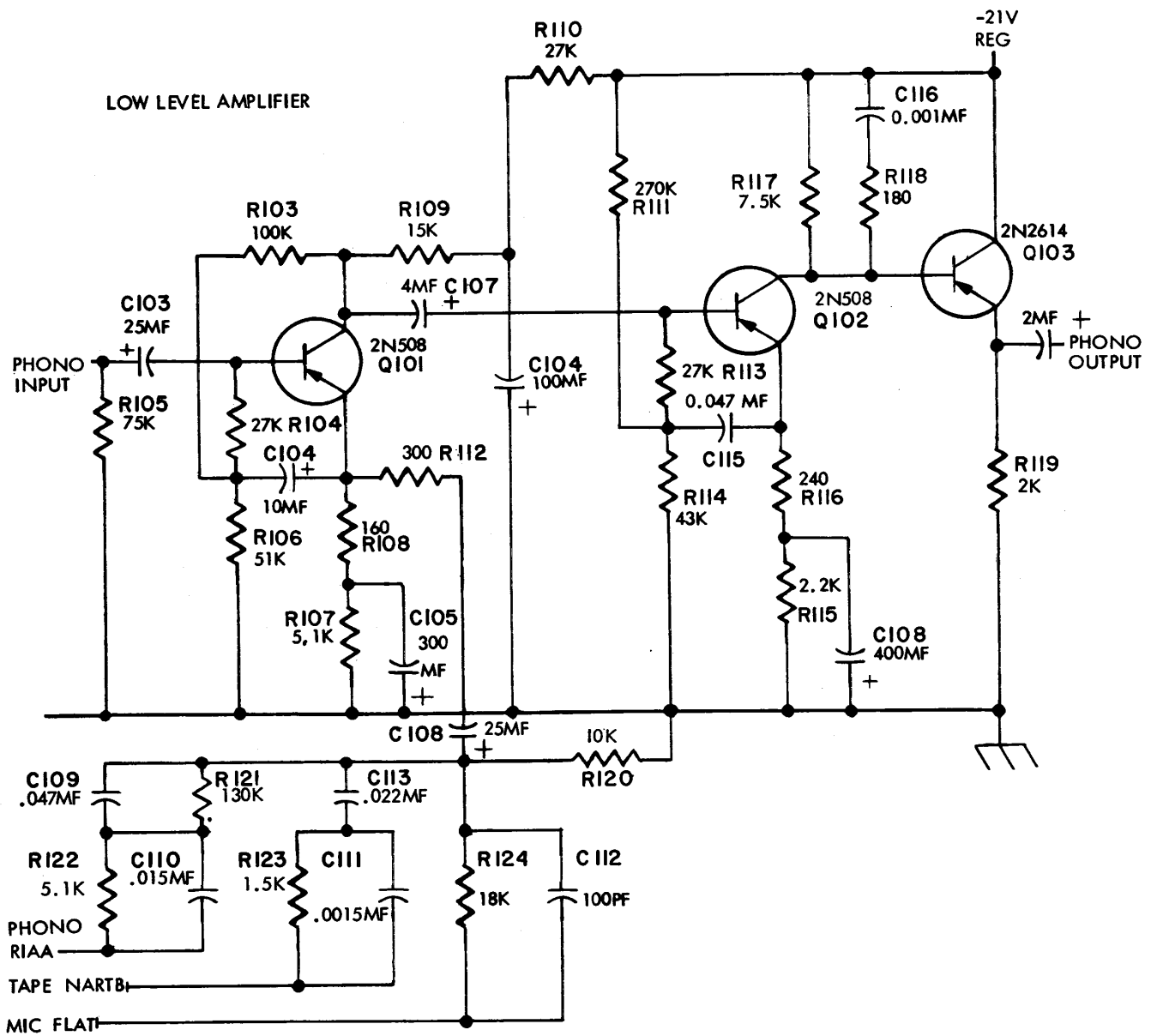

FIGURE 5-1 F22 COMPONENTS



LOW LEVEL AMPLIFIER

AMPLIFIER CIRCUIT BOARD

REFERENCE NO.	DESCRIPTION	PART NO.	USER NET
TRANSISTORS			
Q 101, 102, 104 108, 201, 202, 204, 208	2N508 (selected)	11171	\$ 2.00
Q 103, 203	2N2614	11390	.75
Q 106, 109 206, 209	2N2712	11394	.98
Q 107, 110 207, 210	2N3215	11451	4.95
Q 105, 205	2N3638	12095	1.35
CAPACITORS			
C 101, 102, 137 201, 202, 237	REFER TO MAIN CHASSIS	—	—
C 103, 108, 120 127, 131, 135 203, 208, 220 227, 231, 235	25 mF 25V	11397	1.20
C 104, 132, 204 232	10 mF 6V	11402	.81
C 105, 205	300 mF 6V	11395	1.41
C 106, 206	100 mF 15V	11396	1.20
C 107, 118, 133 207, 218, 233	4 mF 25V	11400	.87
C 109, 115, 121 209, 215, 221	.047 mF 100V	11408	.24
C 110, 210	.015 mF 10%	12009	.39
C 111, 211	.0015 mF 5%	12012	.30
C 112, 212	.0001 mF 500V	11409	.27
C 113, 213	.022 mF 10%	12010	.39
C 114, 125 214, 215	400 mF 3V	11398	1.41
C 116, 130, 134 216, 230, 234	.001 mF 500V	11404	.24
C 117, 123 217, 223	2 mF 25V	11401	.81
C 119, 219	75 mF 25V	11403	1.32
C 121, 221	.47 mF 100V	11407	\$.54
C 122, 222	Refer to Front Panel	—	—
C 124, 224	200 mF 15V	11932	1.44
C 126, 226	100 mF 6V	11931	1.20
C 128, 129 228, 229	.1 mF 100V	11405	.54
C 136, 236	.005 mF 500V	11412	.24
RESISTORS			
R 101, 102, 107 122, 125, 158 201, 202, 207 222, 258, 225	5100 OHM 1/2W 5%	11461	.30
R 103, 127, 129 133, 203, 227 229, 233	100K OHM 1/2W 5%	10072	.30
R 105, 205	75K OHM 1/2W 5%	10842	.30
R 106, 151, 153 206, 251, 253	51K OHM 1/2W 5%	11047	.30

AMPLIFIER CIRCUIT BOARD CONT.

REFERENCE NO.	DESCRIPTION	PART NO.	USER NET
CAPACITORS			
R 108, 208	160 OHM 1/2W 5%	11456	.30
R 109, 155 209, 255	15K OHM 1/2W 5%	11046	.30
R 104, 110, 113 152, 204, 210 213, 252	27K OHM 1/2W 5%	10255	.30
R 111, 132, 211 232	270K OHM 1/2W 5%	11469	.30
R 112, 212	300 OHM 1/2W 5%	12013	.30
R 114, 136, 214 236	43K OHM 1/2W 5%	11608	.30
R 115, 143, 150 215, 243, 250	2200 OHM 1/2W 5%	10943	.30
R 116, 138 216, 238	240 OHM 1/2W 5%	11458	.30
R 117, 217	7500 OHM 1/2W 5%	11463	.30
R 118, 218	180 OHM 1/2W 5%	11457	.30
R 119, 219	2000 OHM 1/2W 5%	12014	.30
R 120, 137, 154 220, 237, 254	10K OHM 1/2W 5%	11464	\$.30
R 121, 221	130K OHM 1/2W 5%	12011	.30
R 123, 223	1500 OHM 1/2W 5%	10078	.30
R 124, 224	18K OHM 1/2W 5%	11466	.30
R 126, 226 162, 262	REFER TO FRONT PANEL		
R 128, 228	220K OHM 1/2W 5%	10163	.30
R 130, 161 230, 261	4700 OHM 1/2W 5%	10074	.30
R 131, 160 231, 260	1000 OHM 1/2W 5%	10940	.30
R 134, 234	REFER TO FRONT PANEL		
R 135, 235	REFER TO FRONT PANEL		
R 139, 239	REFER TO FRONT PANEL — OUTPUT LEVEL —		
R 140, 240	330 OHM 1/2W 5%	10082	.30
R 141, 241	3600 OHM 1/2W 5%	10942	.30
R 142, 242	56K OHM 1/2W 5%	11930	.30
R 144, 244	560 OHM 1/2W 5%	10952	.30
R 145, 147 245, 247	3000 OHM 1/2W 5%	11460	.30
R 146, 149 246, 249	REFER TO FRONT PANEL — TONE CONTROLS —		
R 148, 248	24K OHM 1/2W 5%	10989	.30
R 156, 159 256, 259	82 OHM 1/2W 5%	11455	.30
R 157, 257	110K OHM 1/2W 5%	11467	.30
L 101, 201	Inductor 100 mH	11413	8.25

FRONT PANEL ASSEMBLY

REFERENCE NO.	DESCRIPTION	PART NO.	USER NET
C 122, 222	Capacitor 2 MFD 100V	11375	\$ 2.25
R 126, 226 162, 262	Resistor 100 OHM 1/2W 5%	11507	.30
R 134, 234	Resistor 270 OHM 1/2W 5%	11508	.30
R 135, 235	Resistor 13K OHM 1/2W 5%	11465	.30
R 139, 239	Pot. 1,000 OHM 10% Output Level	11929	1.80

FRONT PANEL ASSEMBLY (Cont.)

REFERENCE NO.	DESCRIPTION	PART NO.	USER NET
R 146, 149	Slide Pot, Tone Controls	12439	12.00
246, 249			
R 301	Pot. 10K OHM 20% Dual Phono Balance	11845	4.50
R 302, 303	Pot. 10K OHM 20% Dual Phono Balance	11342	4.50
R 304	Slide Pot. Balance Control	12440	21.00
R 305	Slide Pot. Volume Control	12441	21.00
SW 301	Selector Switch Assy.	11355	33.00
SW 302	Mode Switch Assy.	11356	21.00
SW 303	Switch, Tape Monitor	11803	3.15
SW 304, 305	Switch, DPDT, RUMBLE, SCRATCH		
401	Test Tone, Tape, Phono	11361	.54
SW 305	Switch, Loudness	11448	5.45
SW 502 A, B	Power Knob & DPDT Switch	11317	3.90
SW 501	Switch Snap Action, AC Pwr	11380	3.15
C 507	Capacitor, .047 MFD 600V	11941	.36
J 301	Jack, Headphone	11364	3.60
J 103, 203, 105	Jack, Mike, Aux Input,		
205, 109, 209.	Recorder out	11471	.36
F 501	Fuse 3/10 Amp. Slo-Blow	11378	.30
	Fuseholder	11377	.69
	Switch DPDT	11317	\$.54
	Insert Nylon	11470	.21
PL 501, 502, 503			
504	Pilot Light #1820	11420	.48
	Pilot Light Bracket	11482	3.45
	Door Assembly	11354	13.50
	End Cap Left	12205	3.16
	End Cap Right	12202	3.16
	Front Panel	12211	39.00
	Knob, Bass A	11366	3.00
	Knob, Bass B	11367	3.00
	Knob, Treble A	11368	3.00
	Knob, Treble B	11369	3.00
	Knob, Balance	11370	3.00
	Knob, Volume	11371	3.00
	Knob, Loudness	12174	3.00

TEST TONE OSCILLATOR

MODEL SG520	DESCRIPTION	PART NO.	USER NET
REFERENCE NO.			
C 401, 403	Capacitor 2 mF 25V	11401	\$.87
C 402	Capacitor .22 mF 100V	11606	.60
C 404	Capacitor .1 mF 100V	11405	.54
R 401	Resistor 13K OHM 1/2W 5%	11465	.30
R 402	Resistor 6800 OHM 1/2W 5%	11604	.30
R 403	Resistor 1600 OHM 1/2W 5%	11675	.30
R 405	Resistor 10K OHM 1/2W 5%	11464	.30
R 404	Potentiometer 5K OHM	11344	3.39
L 401	Inductor 100 mH	11413	8.25
Q 401	Transistor 2N2614	11390	.75
D 401, 402	Diode 1N2090	11602	1.50

POWER SUPPLY

T 501	Transformer, Power Dom.	11385	\$ 39.00
	Transformer, Power Exp.	11643	45.00
C 501, 502, 503	Capacitor 2000-2000-1000 mF	11605	10.20
C 504, 505	Capacitor 2000 mF	11503	5.70
C 506	Capacitor 2000-2000 mF	11386	9.00
R 501, 502	Resistor 20 OHM 1/2W 5%	11603	.30
R 503	Resistor 270 OHM 1W 5%	11506	.45
R 504	Resistor 1000 OHM 1/2W 5%	10940	.30
R 505	Resistor 2200 OHM 1/2W 5%	10943	.30
R 506	Resistor 5 OHM 5W Wirebound	11392	.78
D 501	Diode Zener	12864	7.65
D 502, 503, 504 505, 506, 507 508, 509	Diode, Bridge Encapsulated	11387	7.30
Q 501	Transistor, 2N176	11840	1.80
Q 502	Transistor, 2N2614	11390	.75
	Socket, 2N176	10028	1.10
	Insulator, Mica 2N176	10027	.15
	Insulator, Capacitor Mtg.	10030	.15
	Terminal Strip, 10 Term.	11391	2.40
	Terminal Strip, 2 Term.	10237	.15
SW 503	Voltage selector		REFER TO MAIN CHASSIS

**REPLACEMENT PARTS LIST AND PRICES
MAIN CHASSIS**

C 101, 102, 137 201, 202, 237	.0068 MFD 500V	13188	\$.20
C 508, 509	.01 MFD 500V	13189	.20
S 501, 502, 503 504, 505, 506	Socket, AC	10182	.48
SW 307	Switch, F22 Relay	11361	.54
F 301	1 amp. Fuse	11611	.30
	Fuse holder	11377	.69
J 101, 102, 104 106, 107, 108 110, 111, 112 201, 202, 204 206, 208, 207 210, 211, 212	Individual Jacks		
SW 503	Input Jack Mounting Strip Assy.	11514	10.50
	110/220V Selector (Export only)	11644	6.60
	Top Cover	11347	6.60
	Bottom Cover	11599	6.60
	Case	12896	24.00
505, 506	Foot, Mounting	11600	.15
	Ground Terminal	10244	.30

F22 PARTS LIST

J1, 2, 3, 4	Input Jack	10021	\$.36
Ry1	Power Relay	11976	7.70
Ry2	A-B Relay	11977	11.50
D1	Silicon Diode	11602	1.20
D2	Diode, Bridge	11387	7.85
C1	Capacitor 500 mF 25V	11147	3.08
F1	4 Amp. Slo-Blo	11774	.30
	2 Amp. Slo-Blo	12612	.30
	Fuse holder	11377	.69
	Binding Post Black	10244	.30

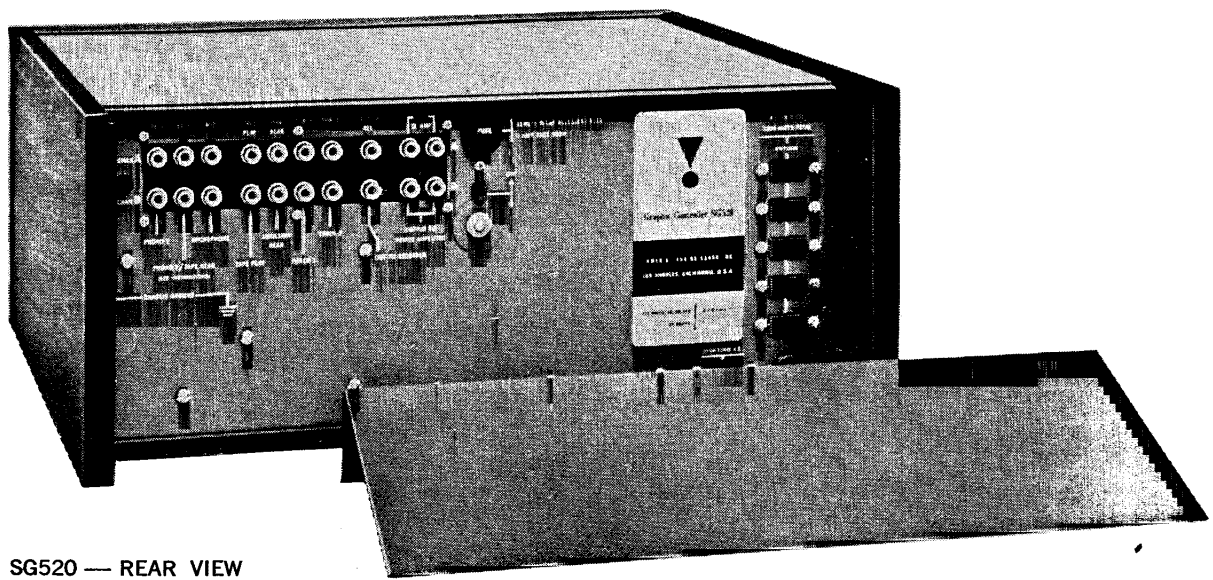

SG520 — REAR VIEW



JBL, 3249 Casitas Avenue, Los Angeles, California 90039
Publication SMSG50 • August, 1968 • Printed in U.S.A.

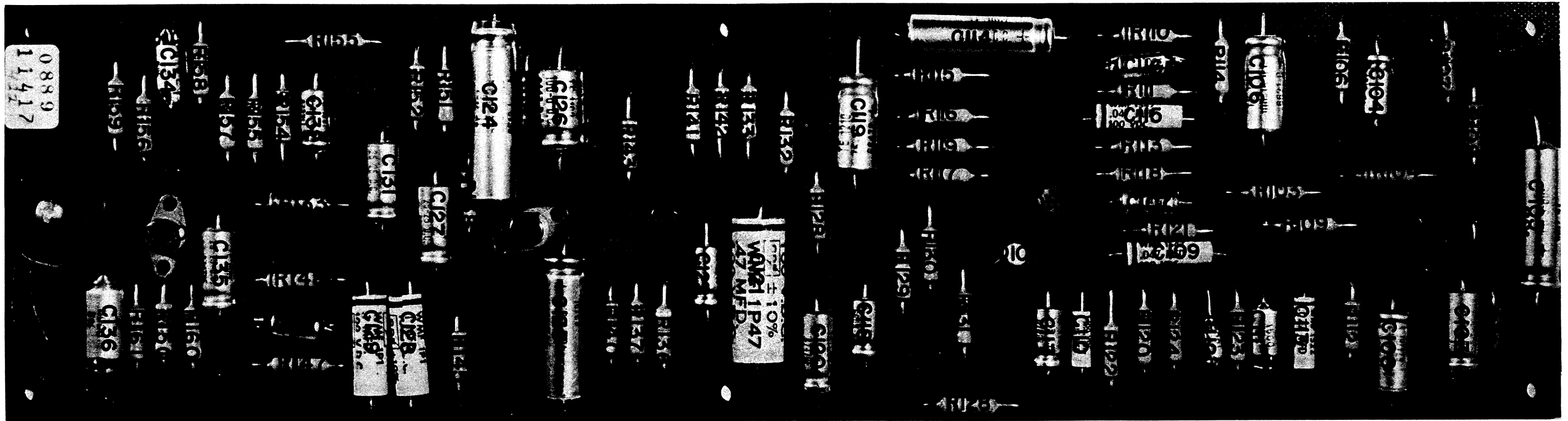

PREAMPLIFIER CIRCUIT BOARD

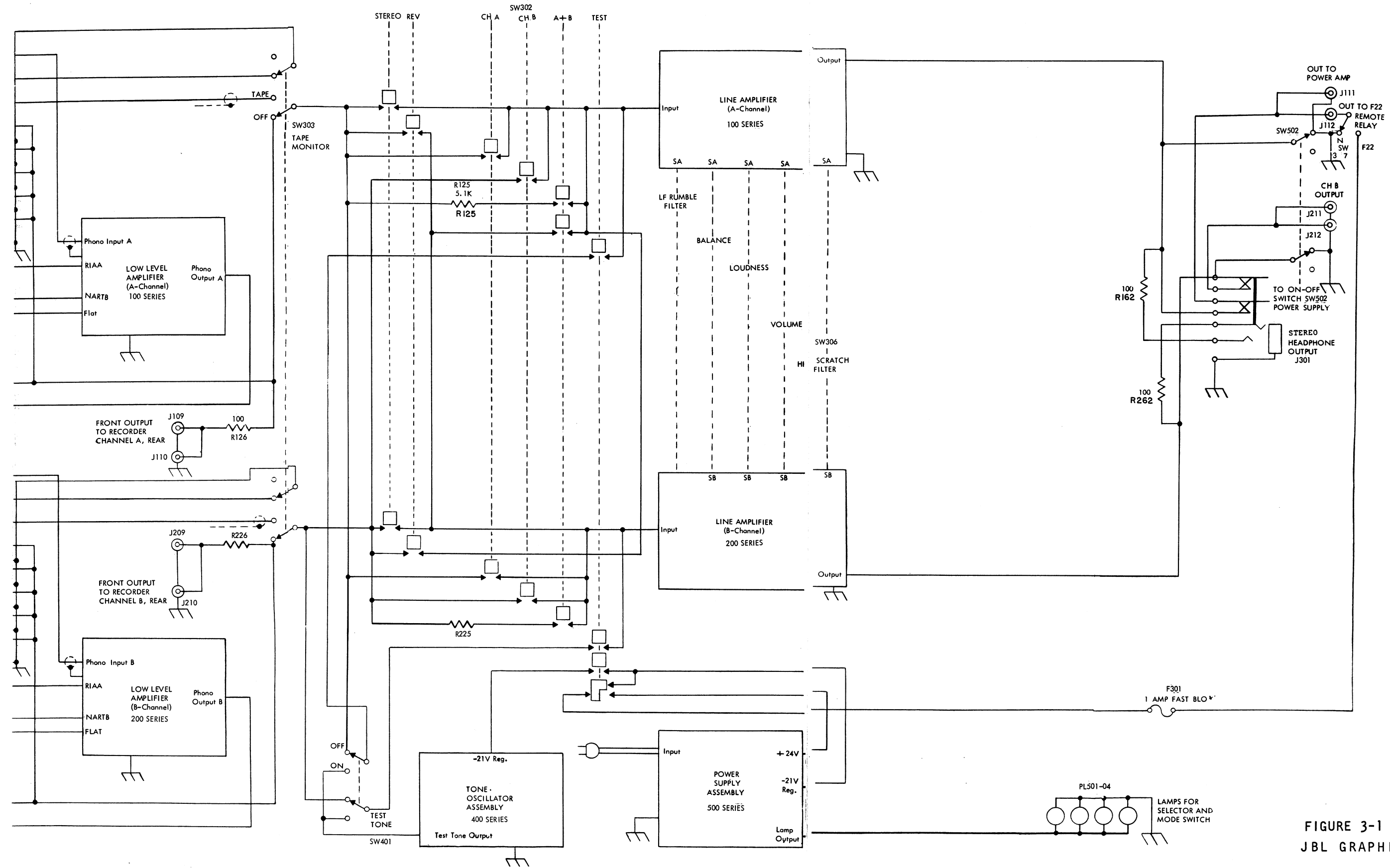
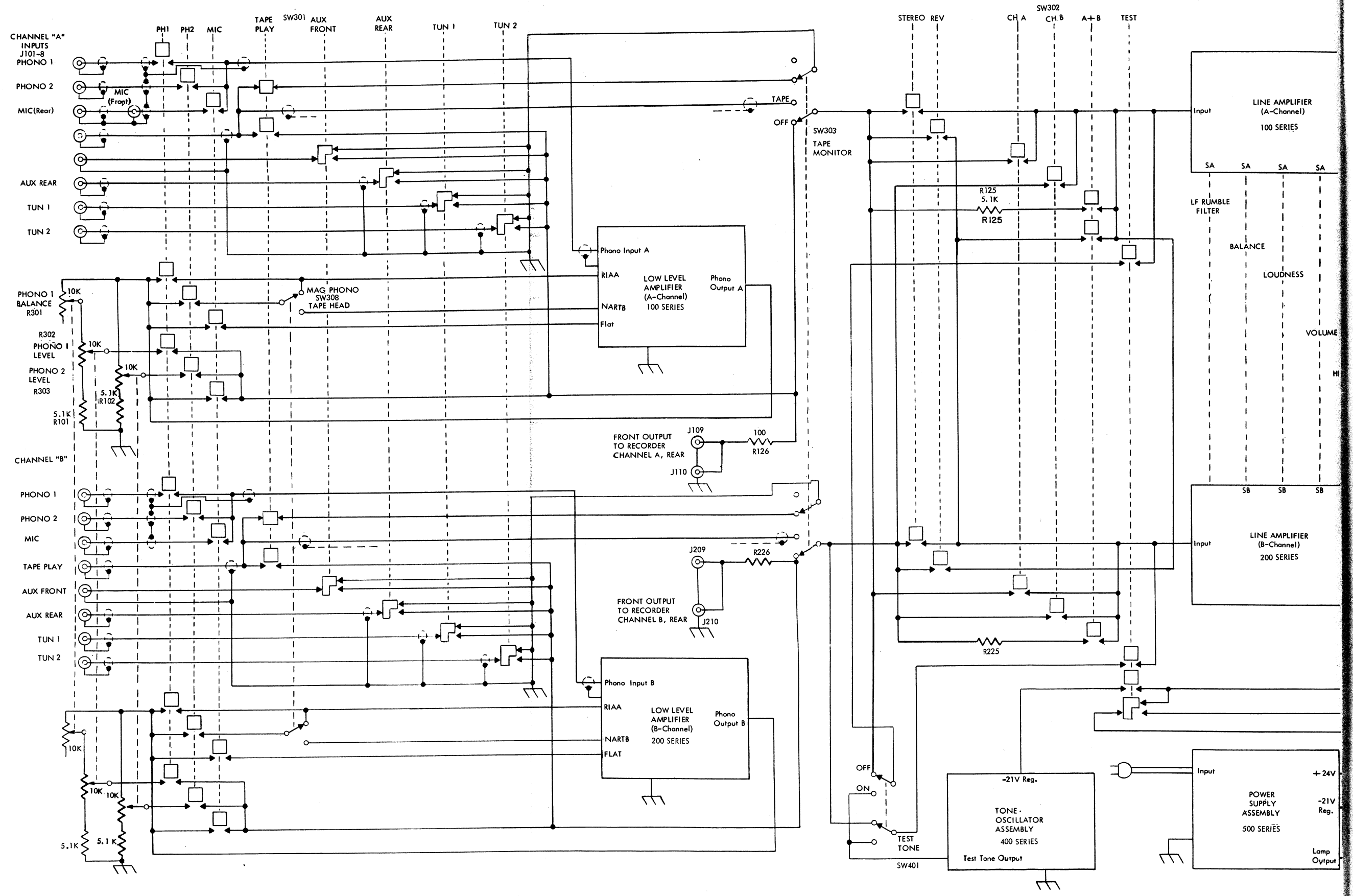
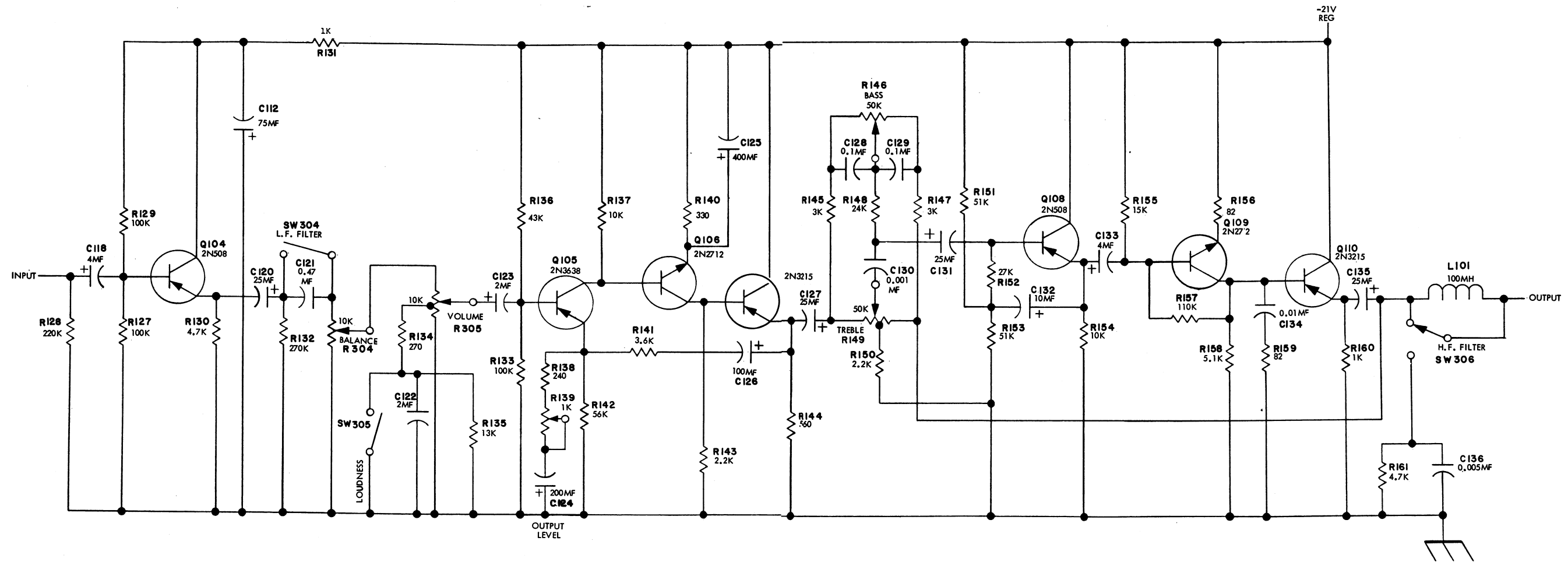
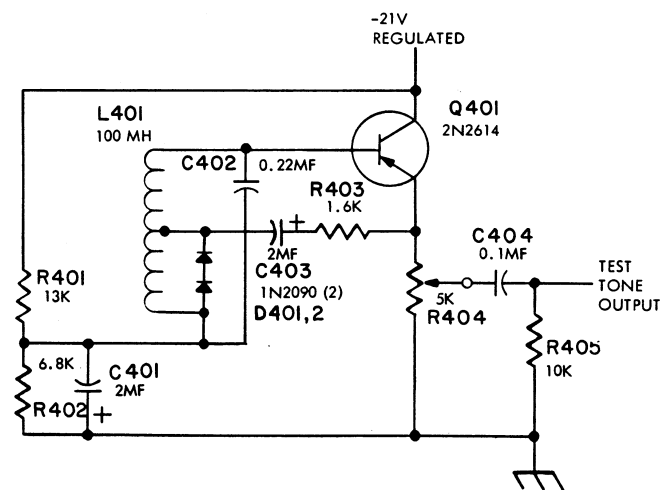

FIGURE 3-1 BLOCK DIAGRAM
JBL GRAPHIC CONTROLLER





LINE AMPLIFIER



TONE OSCILLATOR

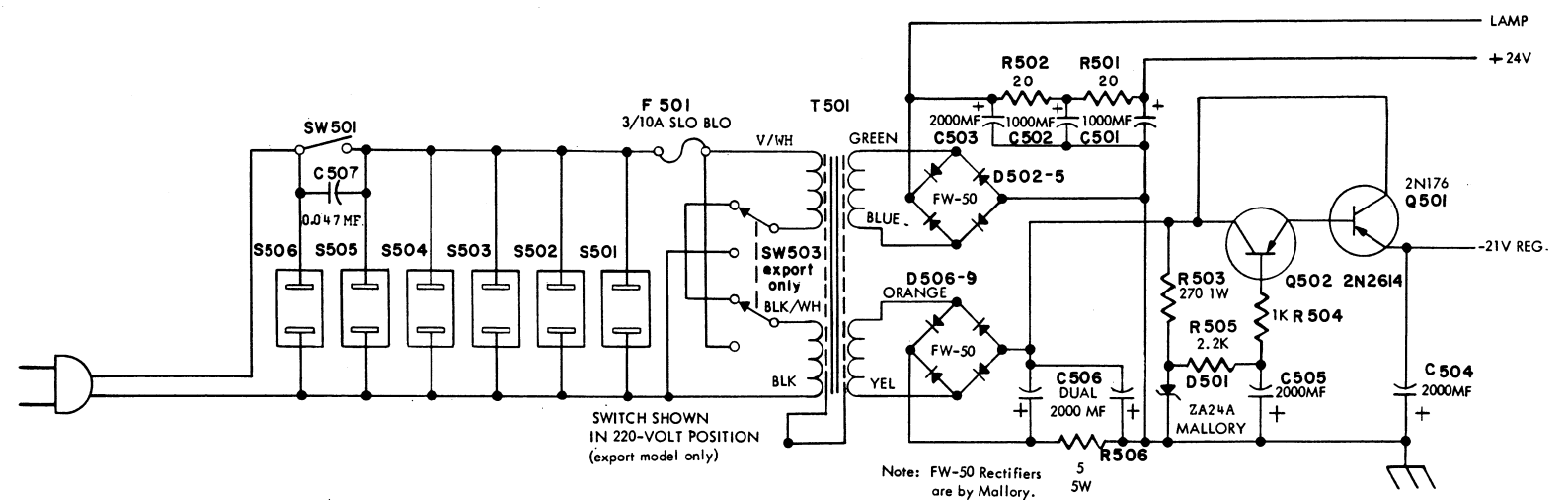

POWER SUPPLY ASSEMBLY

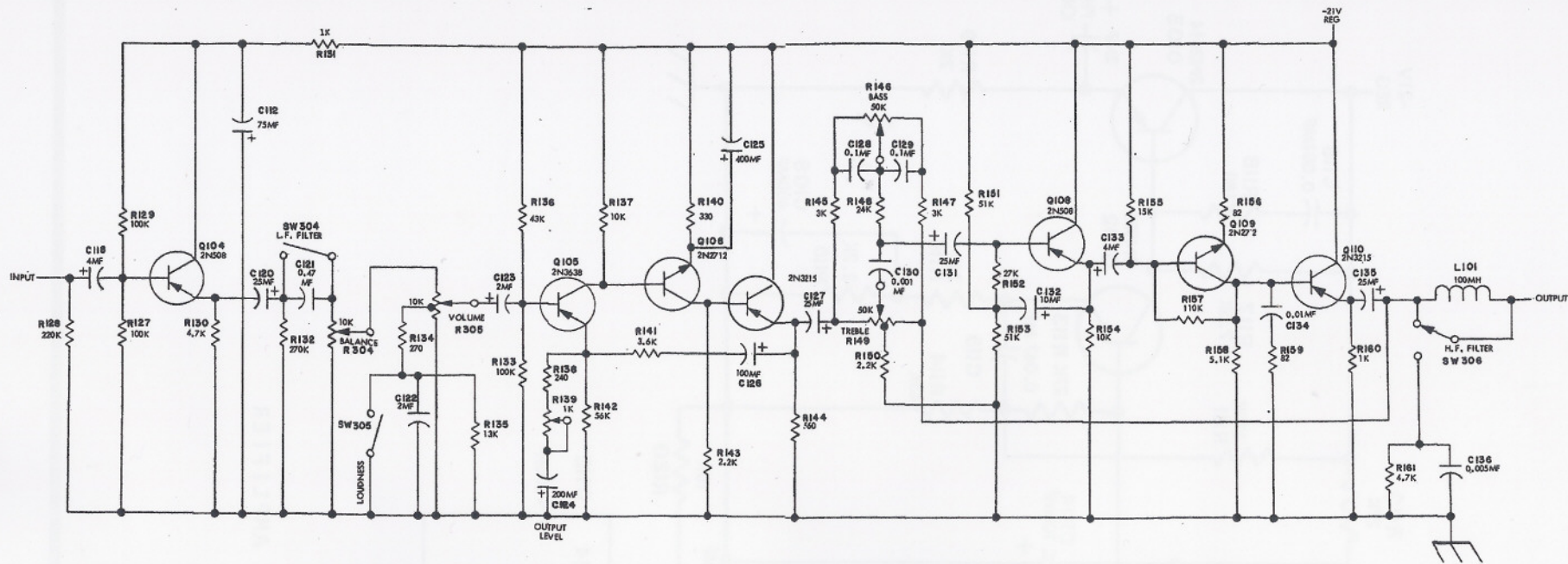

LINE AMPLIFIER

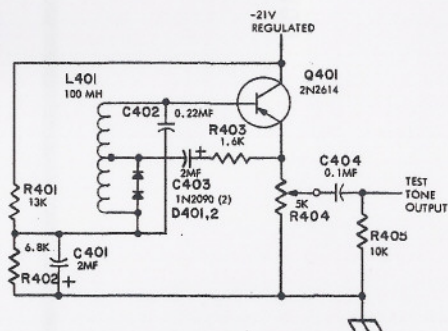

TONE OSCILLATOR

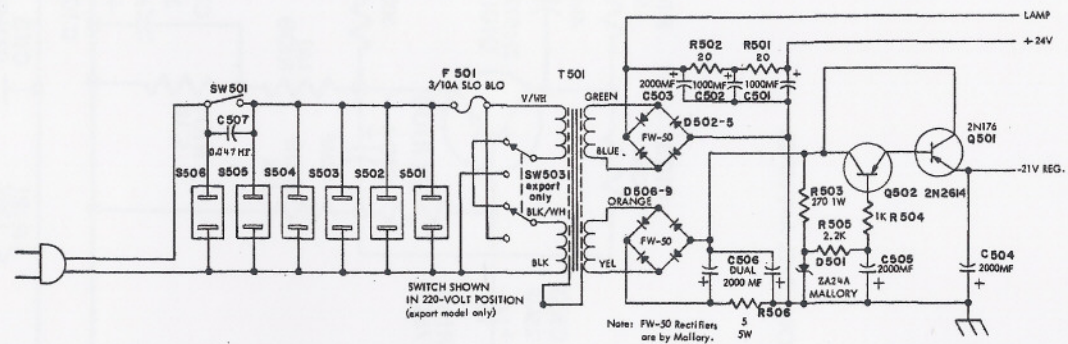

POWER SUPPLY ASSEMBLY

